



Explorer[®] Balances Instruction Manual



TABLE OF CONTENTS

1. INTRODUCTION	5
1.1 Description	5
1.2 Features	5
1.3 Safety Precautions	5
2. INSTALLATION	6
2.1 Unpacking	6
2.2 Installing Components.....	7
2.2.1 Terminal Setup	7
2.2.2 Installing the Wind Ring, Weighing Platform on Models EX124, EX224, and EX324	7
2.2.3 Installing the Sub-Platform and Weighing Pan on Models EX223, EX423, EX623 and EX1103	7
2.2.4 Installing the Weighing Pan on Models EX12001, EX24001 and EX35001	7
2.2.5 Installing the Draft Shield Glass and Doors on Draft Shield Models.....	8
2.2.6 Installing the Weighing Pan & Wind Shield – Non-Draft Shield Models	9
2.3 Selecting the Location.....	9
2.4 Leveling the Equipment.....	9
2.5 Connecting Power	10
2.5.1 Models with AC Adapter.....	10
2.5.2 Models with AC Power Cord	10
2.5.3 Power ON Button on EX12001, EX24001 and EX35001	10
2.6 Connecting the Interface	10
2.7 Adjusting the View Angle of the Terminal	11
2.8 Remote Terminal Operation.....	11
2.8.1 Separating the Terminal from the Weighing Base	11
2.8.2 Terminal Mounting.....	12
2.9 Initial Calibration.....	12
3. OPERATION	13
3.1 Overview of Display, Home Screen	13
3.2 Principal Functions and Main Menu	13
3.3 Overview of Parts and Features –Draft Shield Models	14
3.4 Overview of Parts and Features – Non-Draft Shield Models	15
3.6 Overview of Parts and Features – Terminal	17
3.7 Functions and Their Icons	18
3.7.1 Standby	18
3.7.2 Printing Data.....	18
3.7.3 Zero Operation	18
3.7.4 TouchLess Sensor Status	18
3.7.5 AutoCal™.....	18
3.7.6 Menu	18
3.7.7 More.....	18
3.7.8 Level Assist	18
3.7.9 Applications	18
3.7.10 Taring a Container.....	18
3.7.11 Weighing Units	19
3.7.12 Preset Tare.....	19
3.7.13 Calibration Test	19
3.7.14 Calculator	19
3.7.15 Stopwatch.....	19
3.7.16 Logout	19
4. APPLICATIONS	20
4.1 Weighing	21
4.1.1 Edit Settings	21
4.1.2 Application Setup	22
4.1.3 Statistics for Weighing.....	23
4.2 Parts Counting.....	24
4.2.1 Standard Parts Counting (default).....	24
4.2.2 Application Setup	27
4.2.3 Parts Counting – Check	28
4.2.3 Parts Counting – Fill.....	29
4.2.4 Statistics for Parts Counting.....	30

4.3	Percent Weighing	32
4.3.1	Edit Settings	32
4.3.2	Application Setup	35
4.4	Check Weighing	36
4.4.1	Standard Check Weighing (default)	36
4.4.2	Edit Settings	36
4.4.3	Application Setup	37
4.4.4	Check Weighing – Nominal/Weight Tolerance Mode	38
4.4.5	Check Weighing – Nominal/Percent Tolerance Mode	39
4.4.6	Display Settings	40
4.4.7	Statistics for Check Weighing	41
4.5	Dynamic/Animal Weighing	42
4.5.1	Edit Settings	43
4.5.2	Application Setup	43
4.5.3	Dynamic Weighing – Semi-Auto	44
4.5.4	Dynamic Weighing – Automatic	45
4.5.5	Statistics for Dynamic Weighing	46
4.6	Filling	47
4.6.1	Edit Settings	47
4.6.2	Application Setup	48
4.6.3	Statistics for Filling	49
4.7	Totalization	51
4.7.1	Totalization – Manual (Default)	51
4.7.2	Application Setup	52
4.7.3	Totalization – Automatic	53
4.8	Formulation	54
4.8.1	Free Formulation (default)	54
4.8.2	Application Setup	55
4.8.3	Recipe Formulation	56
4.9	Differential Weighing	59
4.9.1	Item Settings	59
4.9.2	Application Setup	61
4.9.3	Differential Weighing with Auto-Process On	62
4.10	Density Determination	63
4.10.1	Measuring the Density of a Solid Using Water (default)	63
4.10.2	Application Setup	65
4.10.3	Measuring the Density of a Buoyant Material Using Water	66
4.10.4	Measuring the Density of a Solid Using an Auxiliary Liquid	66
4.10.5	Measuring the Density of a liquid using a Calibrated Sinkers (not supplied)	67
4.10.6	Measuring the Density of Porous Material Using Oil	69
4.11	Peak Hold	71
4.11.1	Peak Hold – Semi-Automatic (default)	71
4.11.2	Application Setup	72
4.11.3	Peak Hold – Manual	73
4.11.4	Peak Hold – Automatic	74
4.12	Ingredient Costing	75
4.12.1	Item Settings	75
4.12.2	Application Setup	78
4.13	Pipette Adjustment (not available in EX12001, EX24001, EX35001)	79
4.13.1	Pipette Adjustment – Manual (default)	79
4.13.2	Begin Pipette Adjustment Process	81
4.13.3	Application Setup	82
4.14	Statistical Quality Control (SQC)	83
4.14.1	Edit Settings	83
4.14.2	Begin the SQC Process	84
4.14.3	Application Setup	86
4.15	Statistics	87
4.16	Library	87
4.16.1	Creating a Library Record	87
4.16.2	Retrieving a Library Record	88
4.16.3	Deleting a Stored Library Record	88
4.17	Additional Features	89
4.17.1	Weigh Below	89

5. MENU SETTINGS	90
5.1 Menu Navigation	90
5.1.1 Changing Settings	90
5.2 Main Menu.....	91
5.3 Calibration	91
5.3.1 Calibration sub-menu	91
5.3.2 Internal Calibration (AutoCal™)	91
5.3.3 Automatic Calibration	91
5.3.4 AutoCal™ Adjustment	92
5.3.5 Span Calibration.....	92
5.3.6 User Calibration.....	93
5.3.7 Calibration Test	93
5.4 User Settings.....	94
5.4.1 User Settings Sub-menu	94
5.4.2 Language	94
5.4.3 Volume	94
5.4.4 Display Settings.....	94
5.4.5 User Manager.....	94
5.4.6 Functions Configuration	95
5.4.7 TouchLess Sensor Setup	95
5.4.8 Draft Shield light	95
5.5 Balance Setup.....	96
5.5.1 Balance Set-up sub-menu.....	96
5.5.2 Stable Range.....	96
5.5.3 Filter level	96
5.5.4 Auto Zero Tracking.....	96
5.5.5 Auto Tare.....	97
5.5.6 Gross Indicator	97
5.5.7 Legal For Trade	97
5.5.8 Graduations.....	97
5.5.9 Date & Time	97
5.6 Applications.....	98
5.6.1 Turning an Application ON/OFF	98
5.7 Weighing Units	98
5.7.1 Units Sub-menu.....	98
5.7.2 Turning a Unit ON/OFF	99
5.7.3 Custom Units.....	99
5.8 GLP and GMP Data	100
5.8.1 GLP Data Sub-menu	100
5.8.2 Header.....	100
5.8.3 Balance Name	100
5.8.4 User Name	100
5.8.5 Project Name.....	100
5.9 Communication	101
5.9.1 Communication Sub-menu.....	101
5.9.2 Baud Rate	101
5.9.3 Transmission	101
5.9.4 Handshake	102
5.9.5 Alternate Command	102
5.9.6 Print Output	102
5.9.7 Auto Print.....	103
5.9.8 Print Calibration Data	103
5.9.9 Print Content	103
5.9.10 Print Layout	105
5.9.11 Data Transfer Function.....	105
5.10 Library	107
5.11 I/O Settings.....	107
5.12 Diagnostics.....	107
5.12.1 Level Bubble Light (not available in EX12001, EX24001, EX35001)	107
5.12.2 Draft Shield Light (Analytical models)	107
5.12.3 Sensors	107

5.12.4	Automatic draftshield door	107
5.12.5	Service Menu	107
5.13	Factory Reset	108
5.13.1	Factory Reset Sub-menu	108
5.13.2	Reset Calibration	108
5.13.3	Reset User Settings	108
5.13.4	Reset Balance Setup	108
5.13.5	Reset Application Modes	108
5.13.6	Reset Weighing Units	108
5.13.7	Reset GLP and GMP Data	108
5.13.8	Reset Communication	108
5.13.9	Reset I/O Settings	108
5.13.10	Reset All (Global Reset)	108
5.14	Lockout	109
5.14.1	Lockout Sub-menu	109
5.14.2	Lock Calibration	109
5.14.3	Lock User Settings	109
5.14.4	Lock Balance Setup	109
5.14.5	Lock Application Modes	109
5.14.6	Lock Weighing Units	109
5.14.7	Lock GLP and GMP Data	109
5.14.8	Lock Communication	110
5.14.9	Lock Library	110
5.14.10	Lock I/O Settings	110
5.14.11	Factory Reset	110
5.15	Securing the Menu and Key Lock menu settings	110
5.16	Information	111
5.16.1	Using Information	111
6.	LEGAL FOR TRADE	112
6.1	Settings	112
6.2	Verification	112
6.3	Sealing	112
7.	PRINTING	113
7.1	Connecting, Configuring and Testing the Printer/Computer Interface	113
7.2	Printout Examples	114
7.3	Output Format	122
8.	MAINTENANCE	123
8.1	Calibration	123
8.2	Cleaning	123
8.3	Troubleshooting	123
8.4	Service Information	123
9.	TECHNICAL DATA	124
9.1	Specifications	124
9.2	Drawings and Dimensions	135
9.3	Parts and Accessories	136
9.4	Icons List	137
9.5	Communication	143
9.5.1	Interface Commands	143
9.5.2	RS232 (DB9) Pin Connections	146
9.6	The USB Interface	146
10.	SOFTWARE UPDATES	149
11.	COMPLIANCE	150

1. INTRODUCTION

1.1 Description

The Explorer balance is a precision weighing instrument that will provide you with years of service if properly cared for. The Ohaus Explorer balances are available in capacities from 120 grams to 35,000 grams.

1.2 Features

Modular Design: Ohaus Explorer balances are composed of two interconnected modules: a Terminal and a Base. Depending on the user's needs, the unit can be operated with the Terminal either attached to, or remote from, the Base, with a single interconnect cord 1 meter long.

Touch Controls: Quick, graphical access to all control functions, over a dozen applications and many features.

Touchless Sensors: can be assigned functions when activated: Zero, Print, Tare, Automatic draftshield door etc.

Statistics: available in Weighing, Counting, Percent Weighing, Check Weighing, Dynamic Weighing, Filling.



1.3 Safety Precautions











Caution: Read all safety warnings before installing, making connections, or servicing this equipment. Failure to comply with these warnings could result in personal injury and/or property damage. Retain all instructions for future reference.

- Verify that the input voltage range printed on the data label and the plug type matches the local AC power to be used.
- Make sure that the power cord does not pose a potential obstacle or tripping hazard.
- Use the balance only in dry locations.
- Do not drop loads on the pan.
- Use only approved accessories and peripherals.
- Operate the equipment only under ambient conditions specified in these instructions.
- Disconnect the equipment from the power supply when cleaning.
- Do not operate the equipment in hazardous or unstable environments.
- Service should only be performed by authorized personnel.
- Do not position the balance such that it is difficult to reach the power connection.

2. INSTALLATION

2.1 Unpacking

Carefully remove your Explorer balance and each of its components from the package. The included components vary depending on the balance model (see table below). Save the packaging to ensure safe storage and transport.

Included Component		Photo	EX124 ¹ EX224 ¹ EX324 ¹	EX223 ² EX423 ² EX623 EX1103	EX2202 ² EX4202 ² EX6201 ² EX6202 ² EX10201 EX10202	EX12001 EX24001 EX35001
Terminal			X	X	X	X
Weighing Base			X	X	X	X
Weighing Platform	90 mm Diameter		X			
	130 mm Diameter			X		
	180 x 210 mm				X	
	311 x 371 mm					X
Sub-Platform	130 mm Diameter			X		
Spider						X
Support Caps (4 Pcs)					X	
Wind Ring			X			
Wind Shield					X	
Draft Shield Assembly			X	X		
Power Adapter			X	X	X	
Power Cord	(Country specific)		X	X	X	X
Use Cover	Terminal		X	X	X	X
Compact Disk:	USB Software, Instruction Manual, SPDC , Quick Start Guide		X	X	X	X
Warranty Card			X	X	X	X

Notes: ¹ Includes Automatic draftshield door Model

² Includes ExCal Model

2.2 Installing Components

Refer to the illustrations and instructions below to identify and assemble your Explorer balance with its components. All components must be assembled before using the balance.

2.2.1 Terminal Setup

When the Explorer is delivered, the Terminal is already attached (docked) to the Base. No additional setup is necessary. However, for Draft Shield models, the Terminal needs to be detached temporarily in order to assemble parts of the Draft Shield. Refer to the illustrations and instructions below to identify and assemble your Explorer Balance.

Note: The Terminal is identical for all Explorer Balance models.

2.2.2 Installing the Wind Ring, Weighing Platform on Models EX124¹, EX224¹, and EX324¹

Note: Assembly instructions also apply to models with the suffix M or N.

1. Place the Wind Ring in position.
2. Insert the Platform Assembly onto the Mounting Cone located in the center of the Balance.



2.2.3 Installing the Sub-Platform and Weighing Pan on Models EX223², EX423², EX623 and EX1103

1. Place the Sub-platform in position.
2. Position the Platform on the Sub-platform.



2.2.4 Installing the Weighing Pan on Models EX12001, EX24001 and EX35001

1. Position the Platform on the base.



Notes: ¹ Includes Automatic draftshield door Model
² Includes ExCal Model

2.2.5 Installing the Draft Shield Glass and Doors on Draft Shield Models

1. Carefully remove each of the four glass Draft Shield sections from the packaging.

NOTE: Before installing side doors, be sure to set the lock tabs in the proper position, as shown here.

UNLOCK:



LOCK:



2. Follow the steps below to install side, front and top doors of the Draft Shield.

Side Door Installation

1. Unlock



2. Align



3. Clear



4. Lock



Position glass door to slide. Open lock tab (top); insert in top groove and slide inside bottom groove. Close lock tab.

Front Panel Installation

1. Release terminal



2. Align



3. Push to rear



4. Reconnect terminal



Press button to separate Terminal from Base. Seat panel's hooked ends in base. Swing panel to vertical position.

Top Door Installation

1. Align



2. Press Down



Insert Top Door's hooked ends in grooved pegs. Press gently to seat. Check for smooth movement. Close door.

2.2.6 Installing the Weighing Pan & Wind Shield – Non-Draft Shield Models

Note: Assembly instructions also apply to models with the suffix M or N.

1. Place the four Support Caps onto the Balance as shown.
2. Place the Weighing Pan on the Support Caps
3. Place the Wind Shield onto the Balance as shown.



Note: The balance can be operated without the Wind Shield. However, depending on ambient conditions the displayed results may be slightly less stable.

2.3 Selecting the Location

Avoid excessive vibrations, heat sources, air current, or rapid temperature changes. Allow sufficient space.

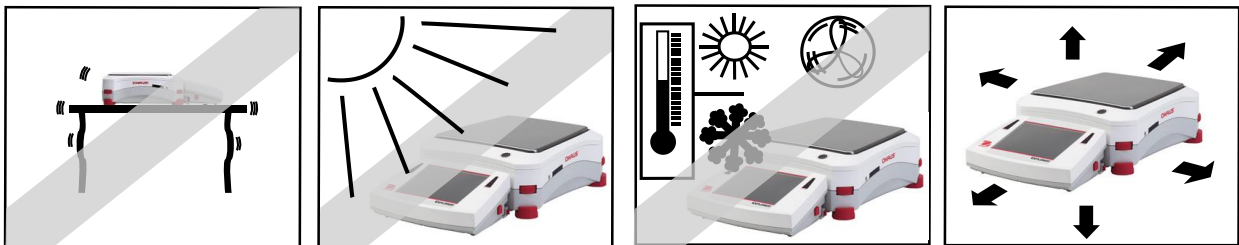

Note: Interface cables connect to the terminal. The terminal can be detached and mounted on a wall or positioned on a table separate from the balance.

2.4 Leveling the Equipment

The Explorer has an illuminated level indicator as a reminder that the balance should be leveled for accurate weighing. There is a level bubble in a small round window on the front of the Base. To level the balance, adjust the **Leveling Thumbwheels** at each corner until the bubble is centered in the circle.

Be sure the equipment is level each time its location is changed.

Note: The feet cannot rotate. The Thumbwheels must be used for leveling.

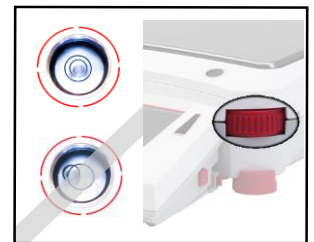

See the Level Assist screen in the Information Menu.

To see the Level Assist menu, touch **More** on the bottom-right corner of the main screen. Then touch **Level Assist**.

The Level Assist screen shows which direction to turn the thumbwheels to center the level bubble.

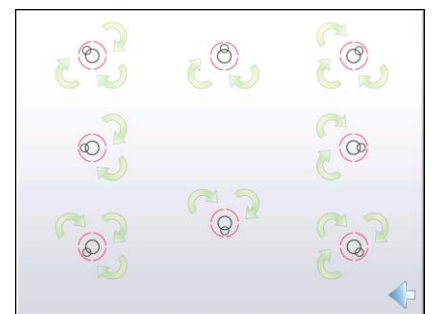

2.5 Connecting Power

2.5.1 Models with AC Adapter

For models supplied with an AC adapter, connect the DC output connector to the power receptacle on the rear of the base. Then connect the AC power cord to a suitable electrical outlet.

Note: EX12001, EX24001 and EX35001 do not have AC Adapter



Caution: For use with CSA certified (or equivalent approved) power source, which must have a limited current output.



Note: Allow equipment to warm up for 60 minutes for optimal weighing performance.



Standby: When unit is plugged in, it starts in **Standby** mode. Press the Standby icon to start.

2.5.2 Models with AC Power Cord

For models with an AC power cord, connect the power cord to a suitable electrical grounded outlet



2.5.3 Power ON Button on EX12001, EX24001 and EX35001

The models EX12001, EX24001 and EX35001 have no AC Adapter. Just connect the power plug to a suitable electrical outlet and press the ON button on the side of the base (see figure below).



Power ON Button

Power ON button on the side of the base (EX12001, EX24001 and EX35001)

2.6 Connecting the Interface

Use the built-in RS-232 (10101) Port to connect either to a computer or a printer with a standard (straight-through) serial cable. Or connect using the scale's USB ports.

Note: For configuration and interface commands, see the Communication Menu Settings section. For Connecting, Configuring and Testing the Printer/Computer Interface, and for sample Print Output Formats, see the Printing section.



Interface connections on back of Terminal.

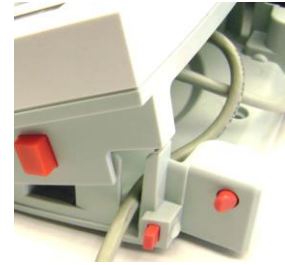

Thread printer cable along cable coils on bottom of balance. Or pass cable through groove near release button.

2.7 Adjusting the View Angle of the Terminal

To adjust the Terminal display's viewing angle, press in the Terminal Adjust buttons on both sides of the Terminal.

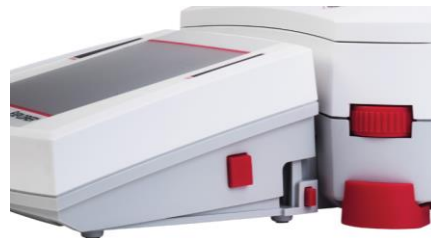

2.8 Remote Terminal Operation

The Terminal communicates with the weighing base via the Terminal cable. This cable must be plugged into the Terminal for the Explorer to display properly. If desired, the Explorer balance may be operated either with the Terminal attached (as-shipped), or remotely (up to 1 meter away).

2.8.1 Separating the Terminal from the Weighing Base

1. To detach, press both the Release buttons inward (both at the same time) and gently pull the Terminal towards you (outward) until the Terminal is detached. These Release buttons disengage the two hooks holding the Terminal to the Base. A cable is attached to the Terminal. Take care to not damage or disconnect this cable.
2. To reattach the Terminal, press in the two Release buttons and slide the Terminal into the Base until the Terminal hooks click and engage to hold the Terminal in place.

Release Button



Base and Terminal



Terminal Cable



Note: If a longer operation distance is required, a Terminal Extension cable is available as an accessory.

2.8.2 Terminal Mounting

If desired, the Terminal may be mounted to a wall or table using fasteners (not supplied) that are appropriate for the type of mounting surface. The Terminal bracket will accommodate 4mm (#8) screws. Locate the mounting holes as shown in Figure 2-1.

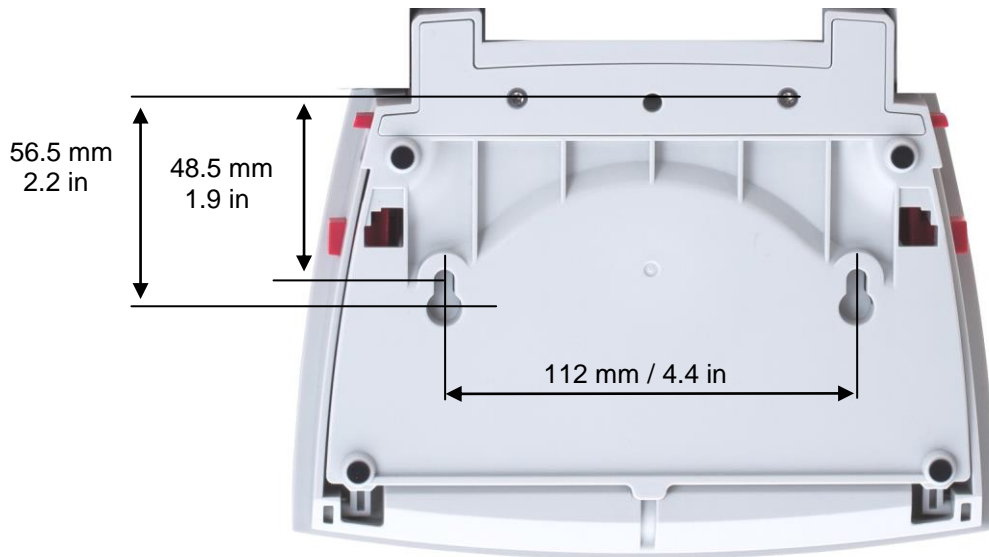

Figure 2-1. Terminal Mounting Dimensions.

2.9 Initial Calibration

When the Balance is first installed, and when it is moved to another location, it must be calibrated to ensure accurate weighing results. The Explorer Balances have built in AutoCal which can calibrate the balance automatically and does not require calibration masses. If preferred, the balance can be manually calibrated with external masses. Have the appropriate calibration masses available before beginning calibration. Refer to the Calibration Section for masses and calibration procedure.

3. OPERATION

3.1 Overview of Display, Home Screen

This equipment utilizes a touch-sensitive display. *Touch* areas and Buttons to control the equipment's functions.

CONTROLS









The screenshot shows the Home Screen of the Explorer Balance. At the top, there are two dropdown menus: 'Dynamic Weighing' and 'Library'. To the right of these is an information icon. Below the menus is an instructional message: 'Place sample on the pan. Press Begin Dynamic to start averaging.' The main display shows a large weight reading of '518.92 g'. To the right of the reading is a battery life indicator. Below the reading is a 'Capacity Guide' bar showing '0' out of '10200.00'. In the center, it says 'Averaging Time: 10 s'. At the bottom, there are several buttons: 'Edit Settings', 'Tare', 'Statistics 0', 'Accumulate', and 'Begin Dynamic'. Below these buttons is a row of icons for 'Standby', 'Print', 'Zero', 'Sensors', 'AutoCal™', 'Menu', and 'More...'. Annotations with arrows point to various elements: 'Touch to access application setup menu' points to the wrench icon; 'Touch to change applications' points to the 'Dynamic Weighing' dropdown; 'Touch to access available libraries' points to the 'Library' dropdown; 'Touch for information menu' points to the information icon; 'Instructional Messages' points to the text above the weight; 'Stability (*), Net (NET), Gross (G) and/or center of zero (>0<) indicators' points to the asterisk; 'Battery life indicator (shown when powered by optional battery pack)' points to the battery icon; 'Touch unit indicator to change weighing unit Capacity or Status Guides: Vary by application' points to the 'g' unit; 'Result Fields: Information varies by application' points to the 'Averaging Time' field; 'Application Buttons: Functions vary by application' points to the bottom row of buttons; and 'Touch icons to perform specific functions or access other functions' points to the bottom row of icons.

3.2 Principal Functions and Main Menu



Weighing: Press **Tare** to set the display to zero. Place an item on the pan. Display indicates gross weight.
Taring: With no load on the pan, press **Tare** to set the display to zero. Place an empty container on the pan and press **Tare**. Add material to the container and its net weight is displayed. Remove container and container's weight appears as a negative number. Press **Tare** to clear.

MENU & SCREEN NAVIGATION

Touch **Menu** to open the menu list.
 Touch and drag the **Scroll bar** to view additional items.

-  **Calibration:**
Touch to view calibration options.
-  **User Settings:**
Touch to view user preferences.
-  **Balance Setup:**
Touch to view balance settings.
-  **Application Modes:**
Touch to view application modes.
-  **Weighing Units:**
Touch to view weighing units.
-  **GLP and GMP Data:**
Insert user data for traceability.
-  **Communication:**
Touch to view COM Device Settings and Print Settings.
-  **Library:**
Touch to delete all Library records.



-  **Diagnostics:**
Touch to view Diagnostics items.
-  **Factory Reset:**
Touch to do a Factory reset.
-  **Lockout:**
Touch to access the Lockout menu list.



I/O Settings:
Touch to view remote I/O Settings.



Information:
Touch to view list of topics.

3.3 Overview of Parts and Features –Draft Shield Models



Figure 3-1. Explorer Balance (including Automatic draftshield door and ExCal models)

3.4 Overview of Parts and Features – Non-Draft Shield Models

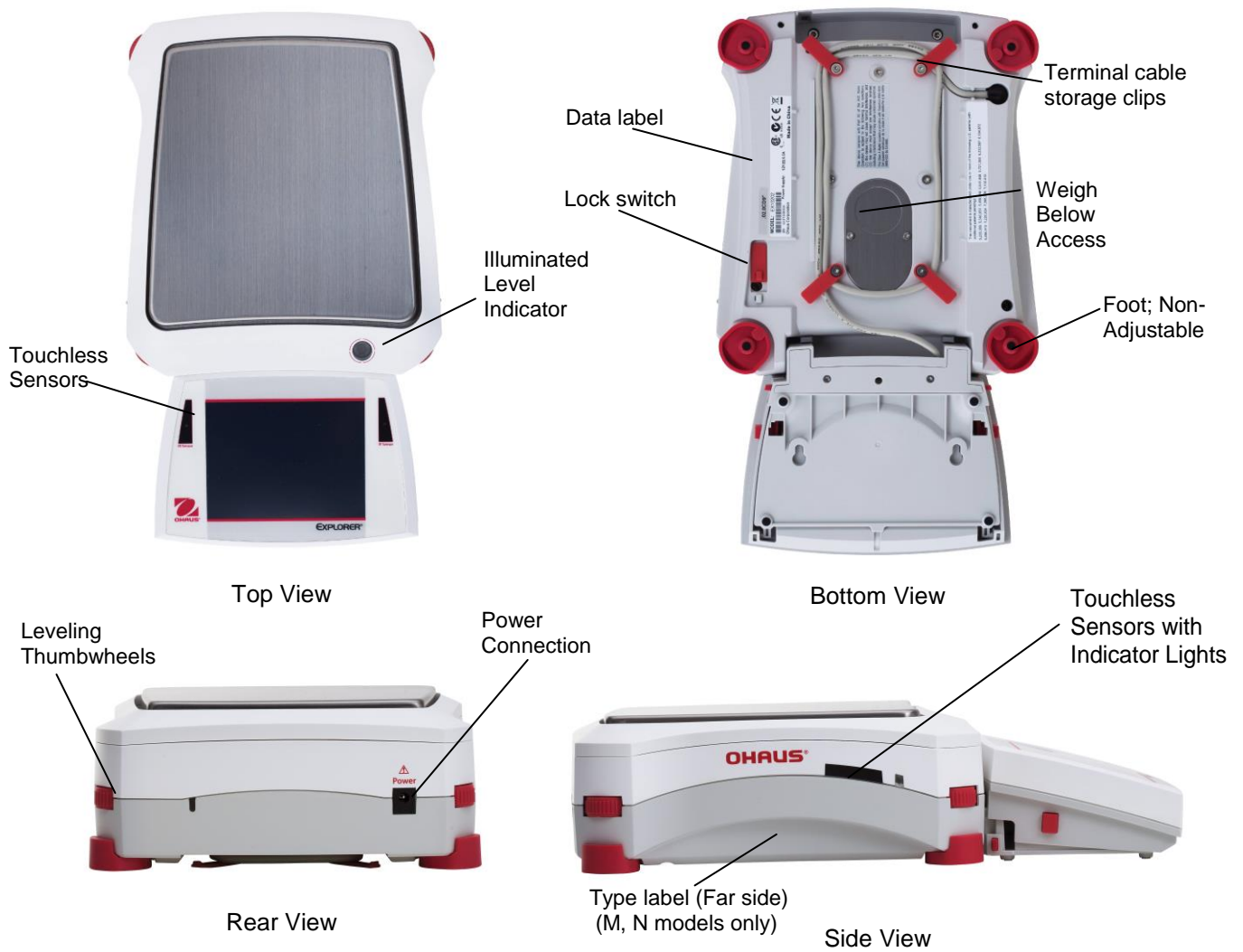

Figure 3-2. Explorer Base

3.5 Overview of Parts and Features – EX12001, EX24001 and EX35001

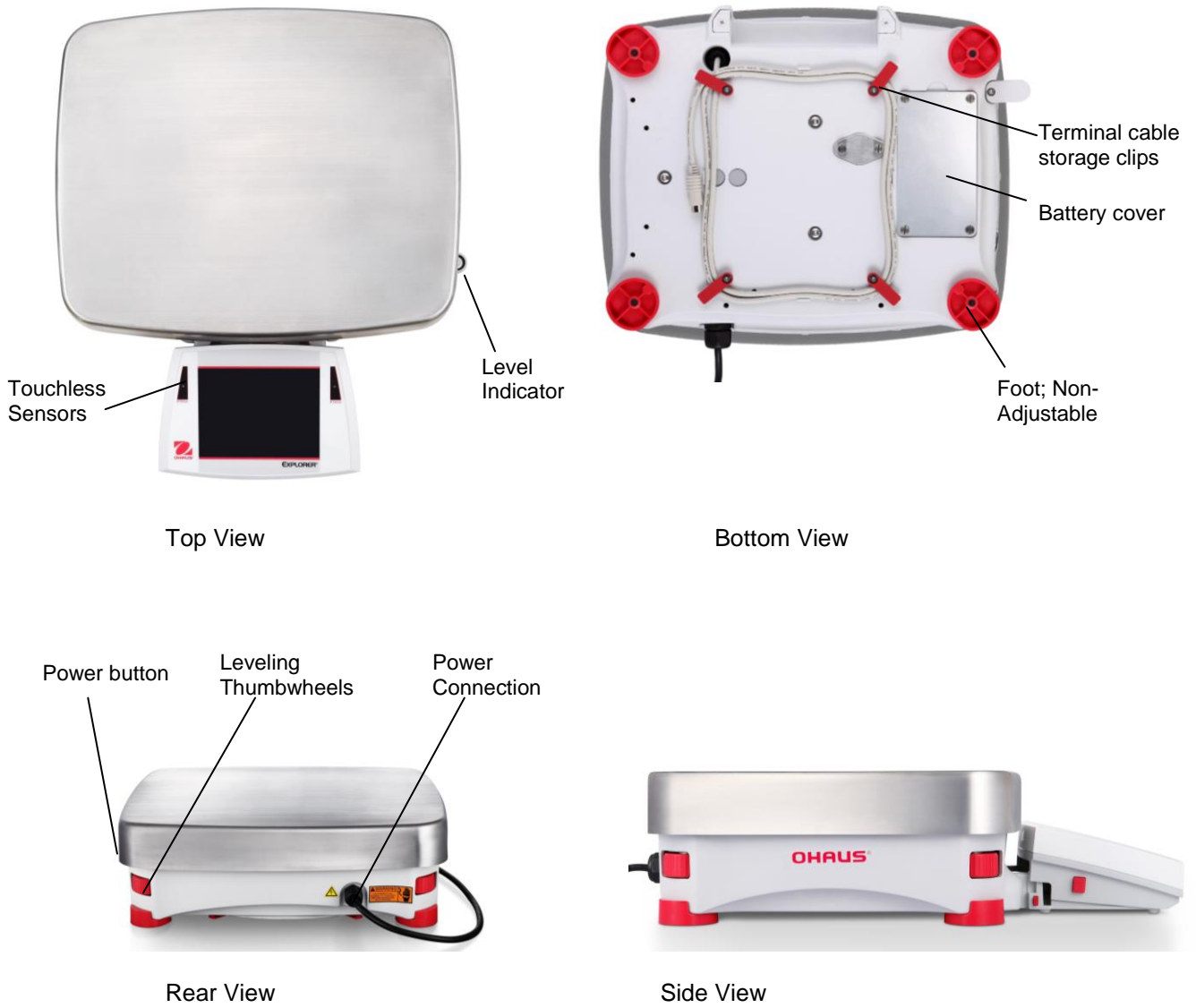
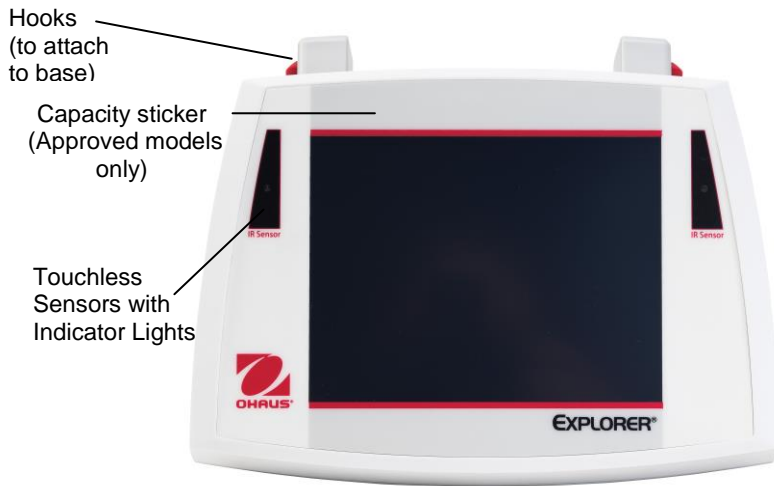
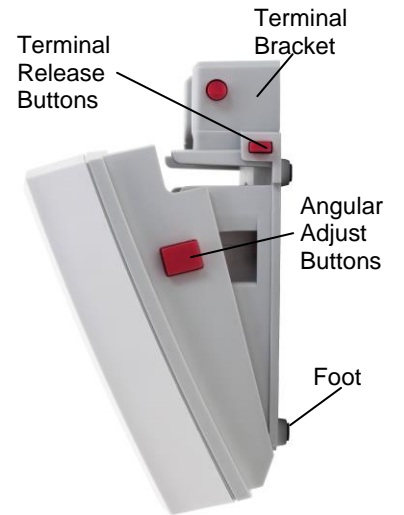

Figure 3-3. Explorer Base

3.6 Overview of Parts and Features – Terminal



Top View



Side View

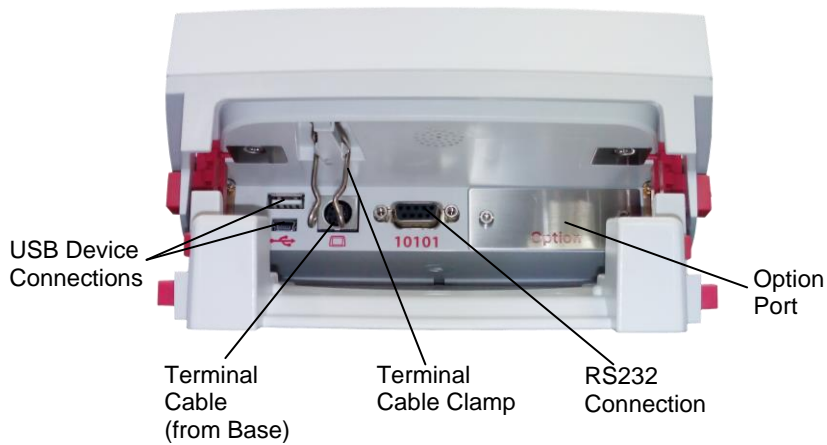

Back View

Figure 3-3. Explorer Terminal

3.7 Functions and Their Icons

Seven Icons are initially available to operate the Balance and access the Menu. These Icons can be customized based on user preference. For setup information, see **User Settings**.



3.7.1 Standby

Touch Standby to shut down the display.

Note: After initial start-up (Section 2), in Standby your balance needs no warm-up time and is immediately available for weighing by touching the Start-up icon.



3.7.2 Printing Data

Touch **Print** to send the displayed value to a printer or computer via the active COM port.

Note: Ensure proper setup of connections, printing and interface parameters.

Note: Data may also be printed using the Touchless Sensors by configuring these for Printing. Data may also be printed using the P command from a computer connected to the COM port.



3.7.3 Zero Operation

Remove the load from the pan and touch **Zero** to set the display to zero. When weighing pan is empty, the **>0<** indicator turns on when the measurement is within $\pm \frac{1}{4}$ division (d) of the zero setting.

Note: The balance also features Auto Zero Tracking (AZT) that automatically maintains a Center of Zero within the tolerances set in the AZT menu (see Balance Settings).



3.7.4 TouchLess Sensor Status

Explorer balances have four **TouchLess** sensors that can be assigned a unique function when activated (e.g., zero, print, tare, Automatic draftshield door etc).

To assign a task for each TouchLess sensor, press **Sensors**.

Note: To activate a sensor, move an object over it (from a distance of 1-2 inches or 3 cm). The sensor shows a green light and beeps when activated. If the sensor cannot be activated (sensor is disabled during certain instances, like when the Menu is displayed) the sensor shows a red light.



3.7.5 AutoCal™

When AutoCal is ON, the balance performs a self calibration. AutoCal will automatically calibrate the Balance (using the internal mass) each time a change in temperature significant enough to affect accuracy, or after every 11 hours.

Touch **AutoCal™** to initiate. (Default status is ON.)

Note: Not available in ExCal



3.7.6 Menu

Touch **Menu** to enter the balance's menu list.



3.7.7 More...

Touch More to access Level Assist, Zero, Tare, Units, Pretare, Cal Test, Calculator, and Stopwatch.



3.7.8 Level Assist

For assistance with Leveling the Balance; the Level Assist screen shows which direction to turn the thumbwheels to center the level bubble.



3.7.9 Applications

The balance can be configured to operate in various Application modes.

Touch Applications to choose – or the top button in the Application area.



3.7.10 Taring a Container

Taring sets the weight of a container as zero, so only the weight of objects held in the container (net weight) is displayed.

Manual Tare – Place the empty container on the pan and touch **Tare** when stable.

Add material to the container. The net weight of the material is displayed.

To clear the Tare value, remove the container from the pan and touch **Tare**.

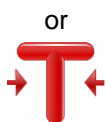



3.7.11 Weighing Units

The balance can be configured to measure in a variety of weighing units, including three (3) custom units. Touch **Units** to choose from the displayed list. *(Scroll down to see all options.)*

Note: The active weighing Unit can also be accessed by touching the unit area of the Main Display line; If a unit is not displayed in the list, it must first be turned on via the User Menu.



3.7.12 Preset Tare

To enter a Preset Tare, press the Icon and then enter a value; enter 0 to clear the Preset Tare. The display will show the PT symbol and the tare value as a negative number.



3.7.13 Calibration Test

is used to compare a known calibration weight against the last stored span calibration data.



3.7.14 Calculator

To use the built-in calculator application, touch **Calculator**. A four function calculator with addition, subtraction, multiplication and division mathematical operations is available.

- Perform a numeric operation using the keypad.
- Press = to view the result.
- To Clear the display: Press **CE** to clear the entry, **C** to clear all
- Touch X to close and return to the current Application.

Note: Calculator is not available in software version 1.10.

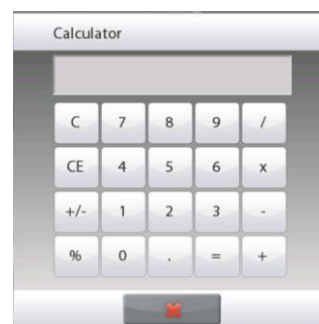

3.7.15 Stopwatch

To use the built-in stopwatch application, touch **Stopwatch**. A countdown timer with interval (lap) timer is available.

- Press Start to begin using the Stopwatch timer.
- Press Reset to reset the timer to Zero.
- Touch Close to close and return to the current Application.

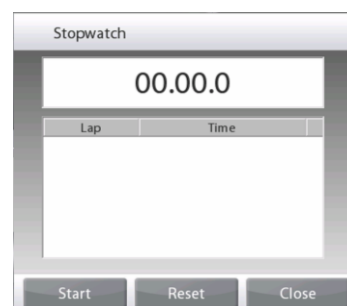

3.7.16 Logout

Used for User logout and return to User Login screen. This feature is only active if a user profile has been created and a User has logged in.

4. APPLICATIONS







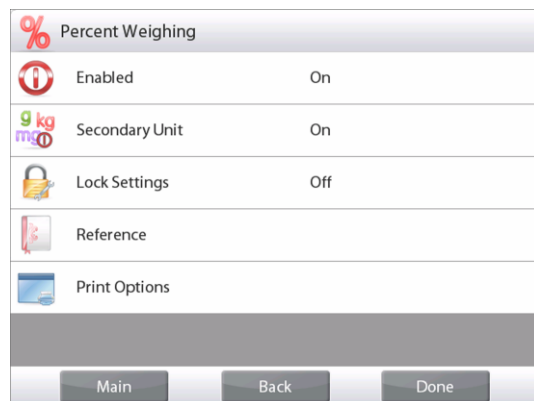
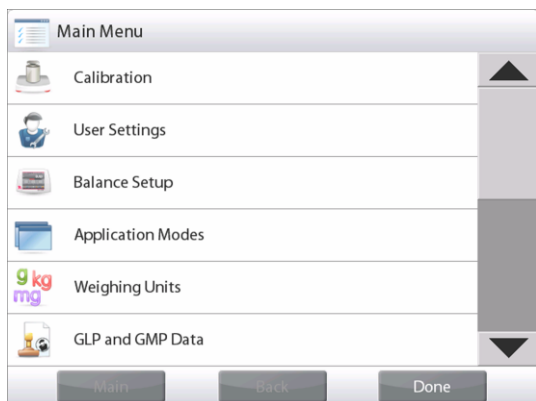







The balance can be configured to operate in various Application modes. Touch **Applications** to choose – or the top button in the Application area:



Note: If an application mode does not appear in the list of available Applications it must be **enabled** in the User Menu: touch **Menu**, then select **Application Modes**. The full list of modes appears. Touch the one you want to enable. Then touch **Enabled** in the setup menu for that application mode – Percent Weighing in the example below. Each enabled mode appears in the **Applications** menu.



The Explorer Balance incorporates the following Applications.

 Weighing	 Parts Counting	 Percent Weighing	 Check Weighing	 Dynamic (Animal) Weighing	 Filling
 Totalization	 Formulation	 Differential Weighing	 Density Determination	 Peak Hold (High Point)	 Ingredient Costing
 Pipette Adjustment (not available in EX12001, EX24001, EX35001)	 Statistical Quality Control (SQC)	 Library (complements most Applications)			

4.1 Weighing

Note: Before using any application, be sure the balance has been leveled and calibrated.

Use this application to determine the weight of items in the selected unit of measure.

Note: The Explorer is shipped with all units enabled.

Weighing

1. In the upper left portion of the home screen, select Weighing (this application is the default).
2. Press **Tare** or **Zero** if necessary to begin.
3. Place objects on the pan to display the weight. When stable, the * appears.
4. The resulting value is displayed in the main Weighing Line in the active unit of measure.



The **WEIGHING** Home screen

Main Display Line

Second Display Line (not shown)

Reference Fields

Application Buttons

Functions



Application Icon

4.1.1 Edit Settings

To view or adjust the current settings

Touch the **Edit Settings** button. The Settings screen appears.

Minimum Weight: establish a minimum weight value to be used to verify a reading. If an actual weight is below the established Minimum Weight value, it is flagged by a color change: **yellow**.

To adjust the Minimum Weight value, touch the **Minimum Weight** button.

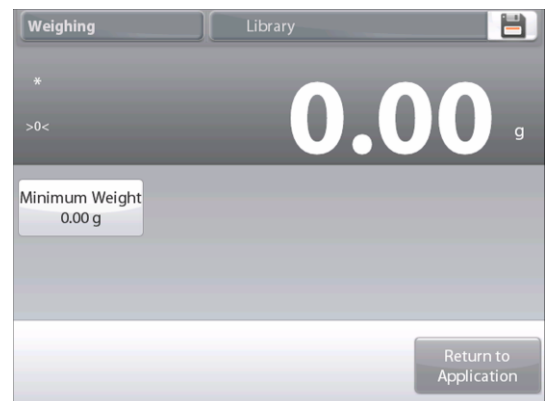

A numeric input window appears.

Use the keys to enter the desired Minimum Weight, then press ✓.

The display reverts to the previous screen with the new Minimum Weight value highlighted: **orange**.

To return to the Weighing home screen, touch **Return to Application** at bottom-right of that screen.



4.1.2 Application Setup

The Application can be customized for various user preferences.

Touch the **Setup Icon** (wrench) to enter **Application Setup**.



The **Application Setup Menu** is now displayed.

Select the list item to view or change the setting as desired.

To return to the Application home screen, touch **Done**.

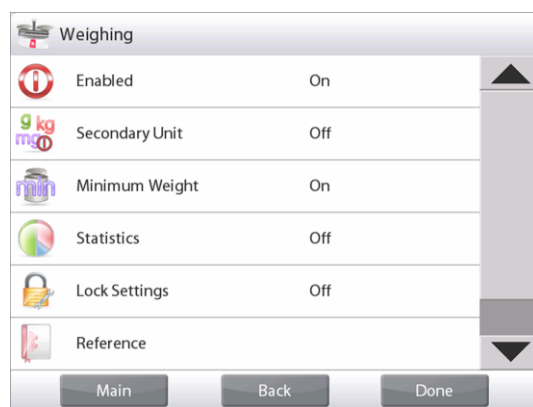

The **Weighing Application Setups** are below (defaults in **Bold**)

Item	Available Settings	Comments
Enabled	On , Off	Turns Application on/off
Secondary Unit	On, Off	To show the Second Display line
Minimum Weight	On , Off	To enable Min Weight
Statistics	Off , Manual, Auto	
Lock Settings	On, Off	Press to lock the current setting(s) so they cannot be changed.
Reference fields		
Min Weight	On , Off	Min Weight is displayed
Gross	On, Off	Gross weight is displayed
Net	On, Off	Net weight is displayed
Tare	On, Off	Tare weight is displayed
Print Options		
Min Weight	On , Off	

4.1.3 Statistics for Weighing

The Statistics function allows you to compare a number of samples and examine the relative deviation of each sample from the mean, along with other statistical data. A minimum of three samples is required.

Statistics can be determined **manually** (requires key press after each step) or **automatically** (weights are automatically recorded when stable). To use the Statistics function, enable it in the Application Setup menu. *This feature is available in **Weighing, Counting, Check Weighing, Dynamic/Animal Weighing** and **Filling** applications.*

Application Setup: First, enable Statistics

Touch the **Setup Icon** (wrench) to enter Setup menu to enable **Statistics**.



The **Statistics options** screen appears.

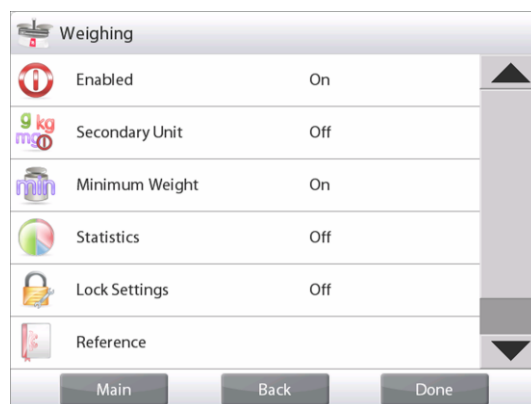

Enable the desired mode (Manual, Auto)
 Press  to return to the Setup menu. After you click your preference, the window will close automatically.

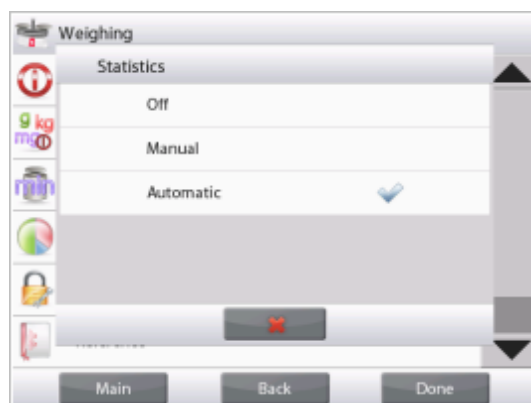

Accumulating displayed values & viewing data – Manual
 Once **Statistics-Manual** is enabled, two buttons appear on the Application screen: **Statistics** and **Accumulate**.

Application – Auto Mode

Statistics Auto mode is similar to Manual mode, except the **Accumulate** button is not shown. The weight of each sample is automatically captured. The current sample must be removed before capturing the next sample.

When stable, the **Statistics** button lights briefly to show the item is added to the set, and the data set quantity increments by one.



Continue to add items to build the data set.
 Press the **Statistics** button to view the results, as shown here.
 Press **Print** to send results to the enabled **COM** port.
 Press **Close** to return to the Application home screen without clearing the current statistics set.
 Press **Clear Data** to clear results and return to the home screen.

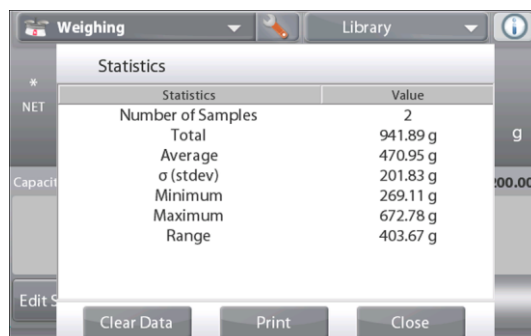

4.2 Parts Counting

Use this application to count samples of uniform weight. Three different modes can be selected: **Standard Counting**, **Check Counting**, or **Fill Counting**.

4.2.1 Standard Parts Counting (default)

In the upper left portion of the home screen, select **Counting**. The default (or last) Average Piece Weight (APW) is displayed.

Place objects on the pan to display the number of pieces.

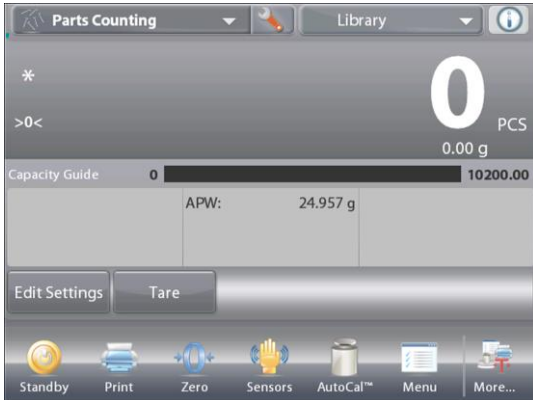

The **PARTS COUNTING-** Standard Home screen

Main Display Line
Second Display Line

Reference Fields

Application Buttons

Functions



Application Icon

Auto Optimization improves counting accuracy: it re-calculates the piece weight automatically as parts are added.

By default Auto Optimization is **Off**.

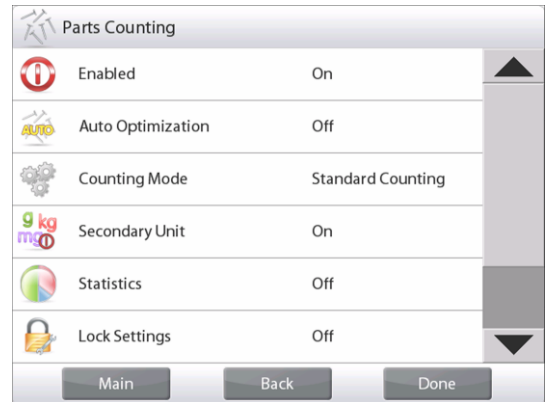

4.2.1.1 Edit Settings: To view or adjust the current settings, touch the **Edit Settings** button:

The Settings screen is now displayed.

Settings available: APW, Sample Size,
Functions available: Recalculate APW,
Return to Application

Establish an Average Piece Weight (APW)

Each time a new type of part is counted, the nominal weight of one piece (Average Piece Weight or APW) must be established using a small quantity of pieces. This APW is stored until replaced by another APW.

There are two methods to establish the APW value:

1. The actual APW is known; or
2. The APW must be derived by weight. For this case the current sample size will be used

To choose a different value, establish it beforehand, using the **Sample Size** button. (See below.)

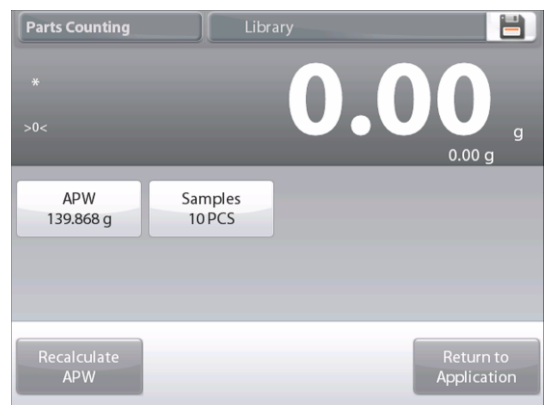

Set a *known* Average Piece Weight (APW)

To adjust the APW value directly, touch the **APW** button. A numeric input window appears.

Key in the desired APW Weight, then press ✓.

The display returns to the previous screen with the new APW value highlighted.

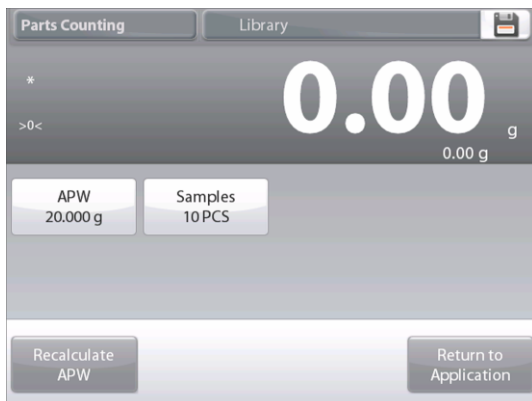
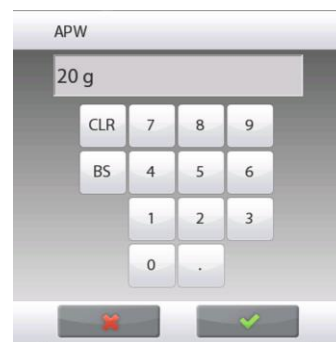

To return to the Counting home screen, touch **Return to Application**.

Set a new Average Piece Weight (APW) – Derived

To establish a new APW, touch the **Recalculate APW** button. The APW Screen is displayed.

Note: The sample size that is displayed will be used. To use a different sample size, change that first. (See below.)

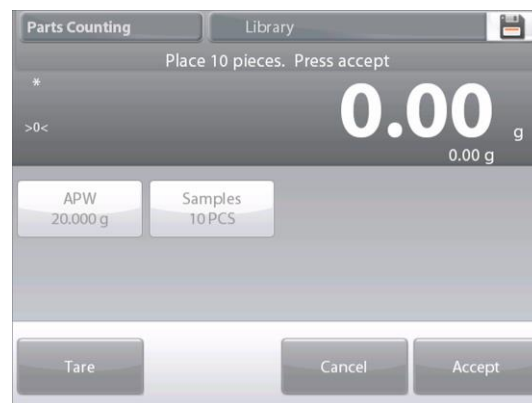

Follow the screen instructions to establish a new APW.

Actions available: **Tare**, **Cancel**, or **Accept**

Press **Accept** to capture the value and return to the Settings screen.

The Settings screen returns with the new APW value highlighted.



To return to the Counting home screen, touch **Return to Application**.

The home screen shows 10 pieces at the new APW



4.2.1.2 Sample Size

The sample size can be 1 to 10 000 pieces. The default sample size is 10. Once a sample size is changed, the balance will immediately open the **Recalculate APW** screen, expecting to establish a new APW.

The current sample size is shown on the **Settings** screen.

To adjust the sample size, touch the **Samples** button.

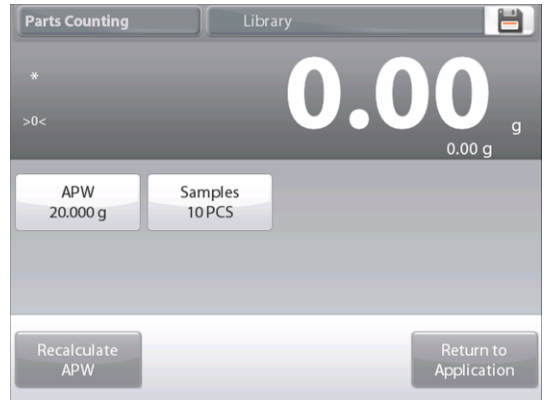

A numeric input window appears.

Key in the desired Sample Size, then press ✓.

The next screen appears, with the message to place the number of pieces entered in the numeric input window.



Place the indicated number of pieces on the platform.

Then touch either **Tare**, **Cancel**, or **Accept**.

Press **Accept** to capture the value and return to the Settings screen.



The Settings screen appears with the new APW value highlighted.

To begin counting pieces, touch **Return to Application**.

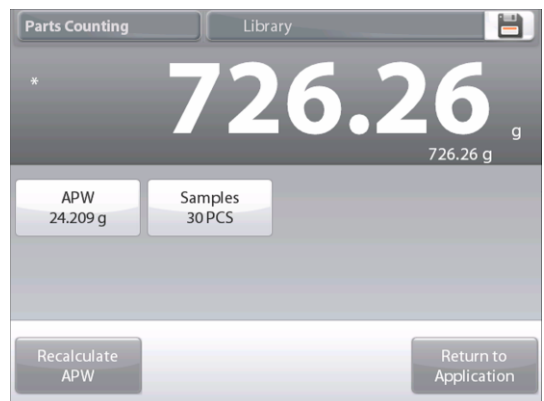

4.2.2 Application Setup

The Application can be customized for various user preferences.

Touch the **Setup Icon** (wrench) to enter **Application Setup**.



The **Application Setup Menu** appears.

Select the list item to view or change the setting as desired.

To return to the Application home screen, touch **Done**.

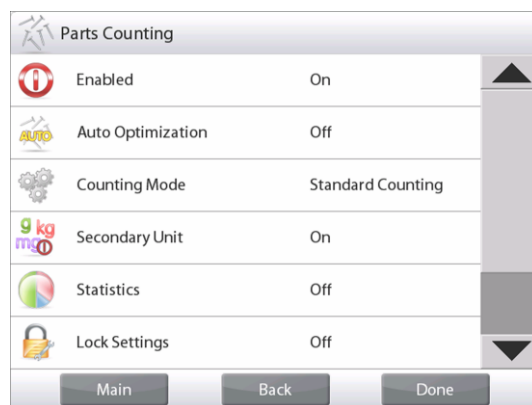

The Counting Application Setups are below (defaults in **Bold**).

Item	Available Settings	Comments
Enabled	On, Off	Turns Application on/off
Auto Optimization	On, Off	
Counting Mode	Standard Counting , Check Counting, Fill Counting	Select the Mode
Secondary Unit	On, Off	To show the Second Display line
Statistics	Off , Manual, Auto	
Lock Settings	On, Off	Press to lock the current setting(s) so they cannot be changed.
Reference fields		
APW	On, Off	The APW is displayed
Gross	On, Off	Gross weight is displayed
Net	On, Off	Net weight is displayed
Tare	On, Off	Tare weight is displayed
Target	On, Off	Used for Check-Fill only
Difference	On, Off	Used for Check-Fill only
Over Limit	On, Off	Used for Check-Counting only
Under Limit	On, Off	Used for Check-Counting only
Print Options		
APW	On, Off	
Sample Size	On, Off	
Target	On, Off	Used for Check-Fill only
Difference	On, Off	Used for Check-Fill only
Over Limit	On, Off	Used for Check-Counting only
Under Limit	On, Off	Used for Check-Counting only

4.2.3 Parts Counting – Check

This feature permits establishing a set quantity of pieces as criteria for similar items that can be quickly checked against a sample.



Press the Setup (wrench) button to enter the Counting Setup menu.



Change Counting Mode to Check Counting.

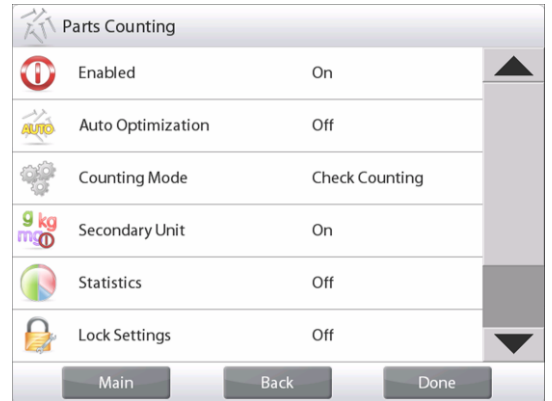

The PARTS COUNTING – Check Home screen

Main Display Line
Second Display Line

Reference Fields

Application Buttons

Functions

The default (or last) Average Piece Weight (APW) is displayed. Place objects on the pan to display the **Check Status** (number of pieces).

4.2.2.1 Edit Settings: To use the Parts Counting-Check mode, the **Over Limit** and **Under Limit** values must be set.

The **Average Piece Weight** and standard sample size can also be set. Follow these steps:

Touch the **Edit Settings** button. The Settings screen appears.

The buttons for **APW**, **Samples**, **Over Limit** and **Under Limit** show default (or previously set) values. To change any value, touch the button. A keyboard screen appears.

(See keyboard screens, next page.)

To set a new average piece weight, press the **Recalculate APW** button.

A new screen appears with the message:

Place 30 pieces. Press Accept
(Default is 10 pieces, but message matches number of pieces in **Samples** button.)

After following these instructions, press **Return to Application** on the main **Edit Settings** screen.

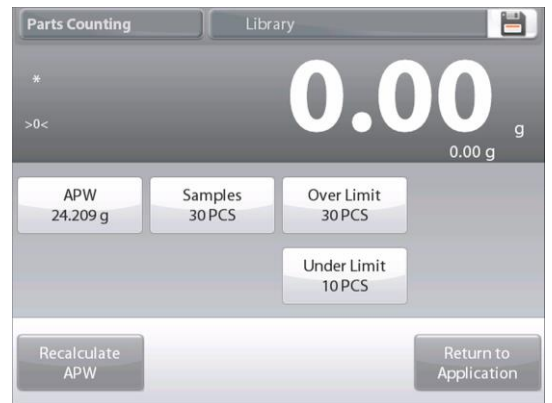

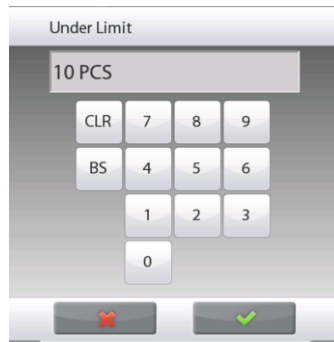

4.2.3 Parts Counting – Fill

This feature permits establishing a set quantity of pieces as a reference, so when pieces are added, their percentage of the reference amount appears. A Progress bar indicates the percentage. In the upper left portion of the home screen, select **Parts Counting**. (The option will appear if it has been enabled in the Application Modes menu.)

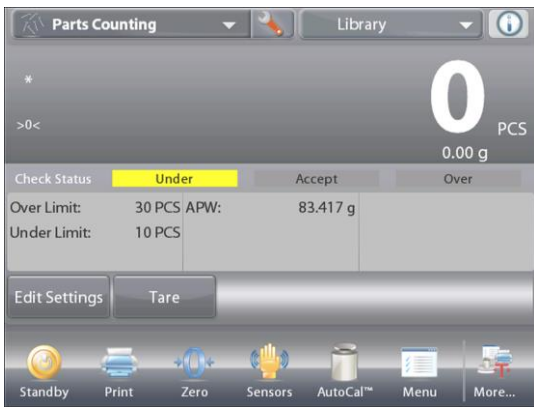

Press the Setup (wrench) button to enter the Counting Setup menu.



Change Counting Mode to **Fill Counting**.

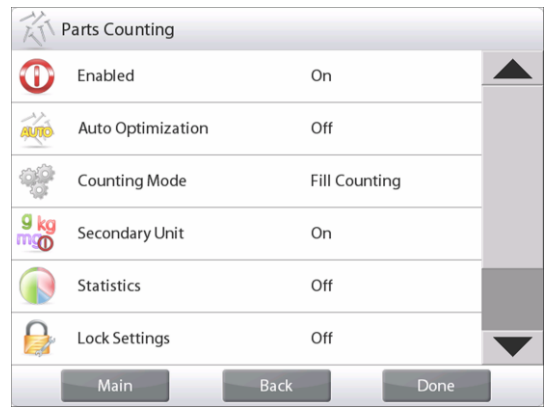

The PARTS COUNTING – Fill Home screen

- Main Display Line
- Second Display Line
- Reference Fields
- Application Buttons
- Functions



The default (or last) Average Piece Weight (APW) is displayed. Place objects on the pan to display the Fill Status.

4.2.3.1 Edit Settings: Touch the **Edit Settings** button. The Settings screen appears. The buttons for **APW**, **Samples** and **Target** show default (or previously set) values. To change values, touch the button. A keyboard screen appears. Key in the new value, and press ✓. To set a new average piece weight, press **Recalculate APW**.



A new screen appears saying:
Place reference weight on the pan. Press Accept to continue.

This establishes a new reference weight with a sample.

Alternatively, fill in values in the screens for **APW, Samples and Target**, as shown below.

After following these instructions, and setting all values as desired, press **Return to Application**.

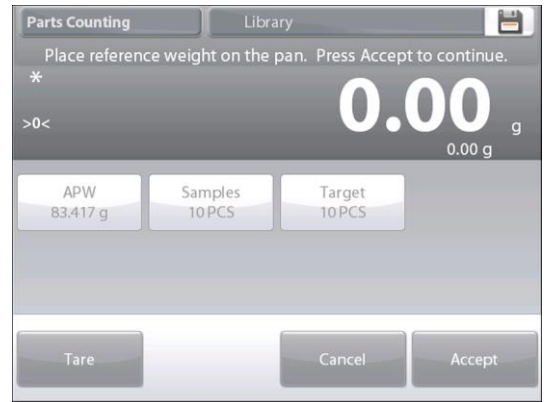

4.2.4 Statistics for Parts Counting

Use the Statistics function to compare a number of samples and examine the relative deviation of the samples along with other statistical data. A minimum of three samples is required.

Statistics can be determined manually (**Manual** mode, with key press after each step) or automatically (**Auto** Mode: weights are automatically recorded when stable).

To use the statistics function, enable it first in the Application Setup menu.

Application Setup

First, Enable Statistics

Touch the Setup Icon wrench (as above) to enter Setup menu.

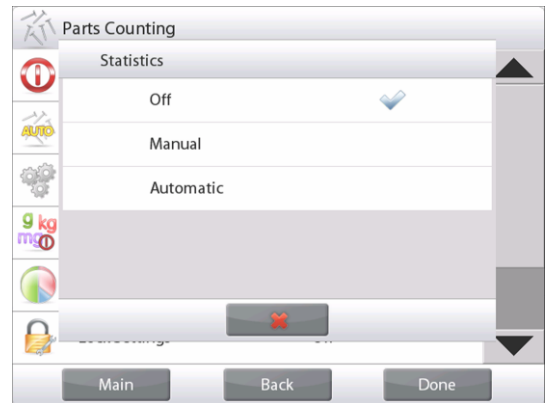
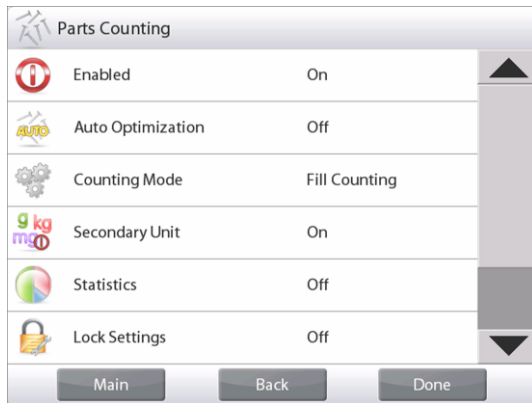

Press **Statistics** and choose either **Manual** or **Automatic**, then press **Close**. Press **Done** on the main options menu to return to the home screen.

Accumulating displayed values & Viewing data – Manual

Once Statistics is enabled, two buttons appear on the Application screen: **Statistics** and **Accumulate**.

To add the sample to the data set, place the item on the pan and press **Accumulate**.

When stable, the Statistics button lights briefly to show the item is added to the set and the data set quantity increments by one.



Continue to add items and press **Accumulate** to build the statistical data set

At any time, press the **Statistics** button to view the results.



The Statistics Results screen

Press **Print** to send to the enabled COM port

Press **Close** to return to the Application home screen with the current statistics set or

Press **Clear Data** to clear the results and return to the Application home screen.

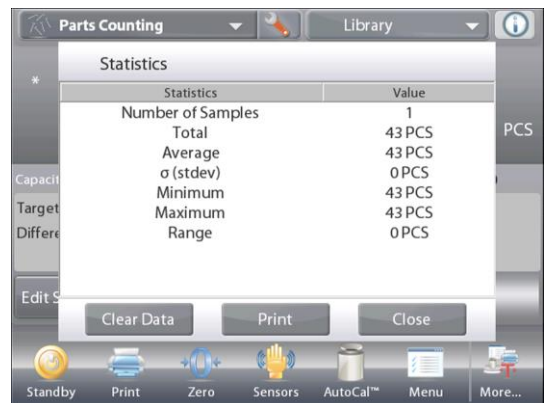

Statistics – Automatic

Statistics Automatic mode is similar to manual mode (above) except the first stable weight is automatically captured. Thus the Accumulate button is not used.

4.3 Percent Weighing

Use Percent Weighing to measure the weight of a sample displayed as a percentage of a pre-established Reference Weight.

The default (or last) Reference Weight is displayed.

Place an object on the pan. The difference between the sample and the Reference Weight is displayed as both a weight and a percentage.

To Access Percent Weighing:

Press the upper left portion of the home screen, so the available Application Modes are visible.

Select **Percent Weighing**.



The **Percent Weighing** Home Screen appears.



The **PERCENT WEIGHING** Home screen

Main Display Line
Second Display Line

Reference Fields

Application Buttons
Functions



4.3.1 Edit Settings

To view or adjust the current settings

To adjust the Application settings, touch the **Edit Settings** button. (See above.)

The Settings screen is now displayed.

Settings available: **Reference, Reference Adjust**

Functions Available: **Recalculate Reference, Return to Application**

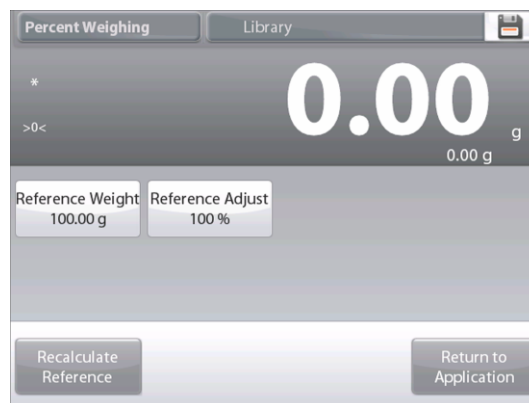

Establishing a Reference Weight

There are two methods to establish the Reference Weight value:

1. **Direct:** If the actual Reference Weight is known, it can be entered directly;
2. **Derived:** The sample's weight can be used to establish the reference weight.

Establishing a Known Reference Weight



The current Reference weight value is shown on the Settings screen. To adjust the Reference weight directly, touch the **Reference** button.



A numeric input window appears.

Key in the desired Reference Weight, then press ✓.

The display returns to the previous screen with the new value highlighted.

To return to the Percent Weighing home screen, touch **Return to Application**.

Using a Sample to Establish a Derived Reference Weight



To establish a new Reference weight value, touch the **Recalculate Reference** button.

The **New Reference** screen appears. Follow the screen instructions to establish a new Reference Weight.

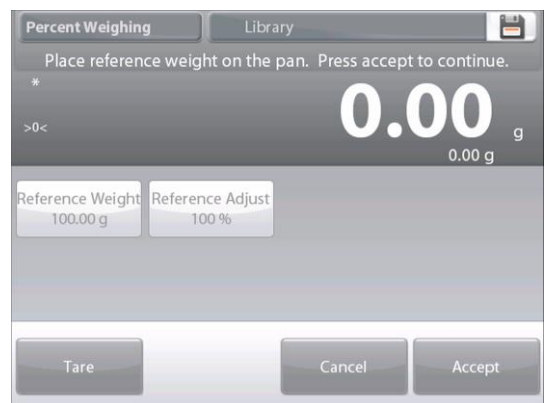

Actions available: **Tare**, **Cancel**, or **Accept**.

Press **Accept** to capture the value and return to the Settings screen.

The display returns to the Settings screen with the new Reference weight value highlighted momentarily.

To return to the Percent weighing home screen, touch **Return to Application**.

Reference Weight Adjustment (Reference Adjust)

The Reference Weight adjustment can be 1 to 1000 percent.

Examples: 100% means the sample is displayed as compared to 100% of the Reference Weight.

25% means the sample is displayed as compared to 25% of the Reference Weight.

The **Edit Settings** screen shows current Reference Adjust value. To change it, touch **Reference Adjust** button.



A numeric input window appears.

Key in the desired Reference Weight Adjustment, then press ✓.



The display returns to the previous screen with the new value highlighted momentarily.

To return to the Percent weighing home screen, touch **Return to Application**.

4.3.2 Application Setup

The Application can be customized for various user preferences. Press **Setup** (wrench) from the home screen.



The **Setup Menu** appears.

Select the item to view or change.

To return to the Application home screen, press **Done**.

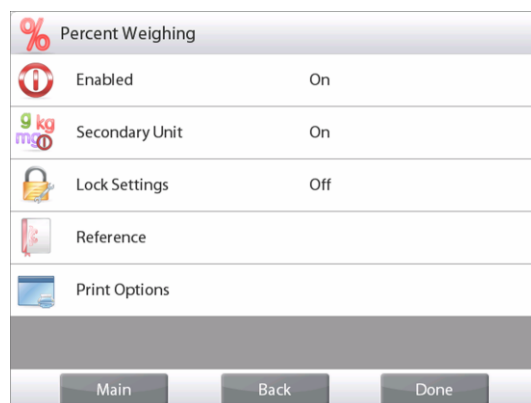

Percent Weighing Application Setups (defaults in Bold)

Item	Available Settings	Comments
Enabled	On , Off	Turns Application on/off
Secondary Unit	On , Off	To show the Second Display line
Lock Settings	On, Off	Press to lock the current setting(s) so they cannot be changed.
Reference fields		
Reference Weight	On , Off	The Reference is displayed
Difference (weight)	On , Off	Displays the Difference to the reference weight.
Difference (percent)	On , Off	Displays the Difference to the reference weight as percentage.
Gross	On, Off	Gross weight is displayed
Net	On, Off	Net weight is displayed
Tare	On, Off	Tare weight is displayed
Print Options		
Reference Weight	On , Off	
Reference Adjust	On , Off	
Difference (weight)	On , Off	
Difference (percent)	On , Off	

4.4 Check Weighing

Check Weighing is used to compare the weight of a sample against target limits. Three different modes can be selected: Over and Under, Nominal Weight Tolerance, or Nominal Percent Tolerance.

4.4.1 Standard Check Weighing (default)

In the upper left portion of the home screen, select **Check Weighing**. The default (or last) Check weigh limits are displayed. Place objects on the pan. The **Under/Accept/Over** status is shown in the progress bar area while the actual weight of the item is shown on the main Display Line.



The **CHECK WEIGHING** Home screen

Main Display Line
Second Display Line

Reference Fields

Application Buttons

Functions



Application Icon

4.4.2 Edit Settings

To view or adjust the current settings

Touch the **Edit Settings** button. The Settings screen appears.

The Application Settings Screen.

Settings available: Over Limit, Under Limit

Functions Available: Return to Application

The check limit values are displayed in the settings screen.

To set the *Over Limit value*, touch the **Over Limit** button

To set the *Under Limit value*, touch the **Under Limit** button

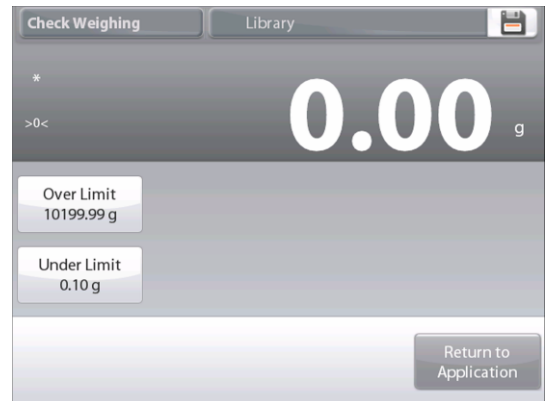

A numeric input window appears.

Enter the desired Limit Weight, then press ✓.

The display returns to the previous screen with the new value highlighted momentarily.

To return to the CHECK WEIGHING home screen, touch **Return to Application**.



4.4.3 Application Setup

The Application can be customized for various user preferences.

Touch the Setup Icon (wrench) to enter the Application Setup from the home screen:



The **Setup** Menu is now displayed.

Select the list item to view or change the setting as desired.

To return to the Application home screen, touch **Done**.

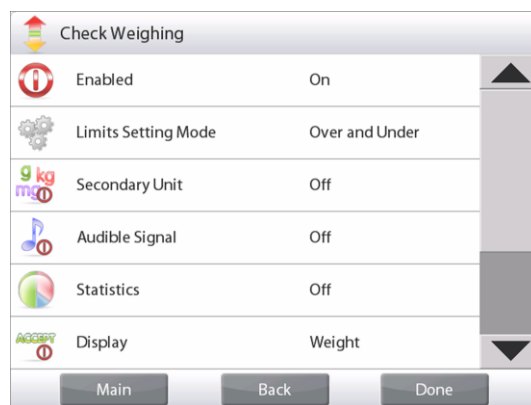

Check Weighing Application Setups (defaults in **Bold**)

Item	Available Settings	Comments
Enabled	On , Off	Turns Application on/off
Limits Setting Mode	Over and Under , Nominal/Weight Tol, Nominal/Percent Tol.	To select the Mode
Secondary Unit	On, Off	To show the Second Display line
Audible Signal	On , Off	Beeps if reading is <i>under</i> or <i>over</i> .
Statistics	Off , Manual, Auto	
Display Setting	Weight , Check Status	To show Weight or Check Status on Main Display Line
Lock Settings	On, Off	Press to lock the current setting(s) so they cannot be changed.
Reference fields		
Over Limit	On , Off	Over weight limit
Under Limit	On , Off	Over weight limit
Gross	On, Off	Gross weight is displayed
Net	On, Off	Net weight is displayed
Tare	On, Off	Tare weight is displayed
Target	On , Off	Used for Nominal Checkweigh
Positive Tolerance	On , Off	Used for Nominal Checkweigh
Negative Tolerance	On , Off	Used for Nominal Checkweigh
Print Options		
Over Limit	On , Off	
Under Limit	On , Off	
Target	On , Off	Used for Nominal Checkweigh
Positive Tolerance	On , Off	Used for Nominal Checkweigh
Negative Tolerance	On , Off	Used for Nominal Checkweigh

4.4.4 Check Weighing – Nominal/Weight Tolerance Mode

With this feature you can establish a Target or Nominal weight value and pre-set tolerance in weight.

To enable this feature, enter the **Setup** menu.



Change the mode to **Nominal/wt. Tolerance**.
The Check Weighing options screen returns.

Press **Done** to begin Check Weighing.

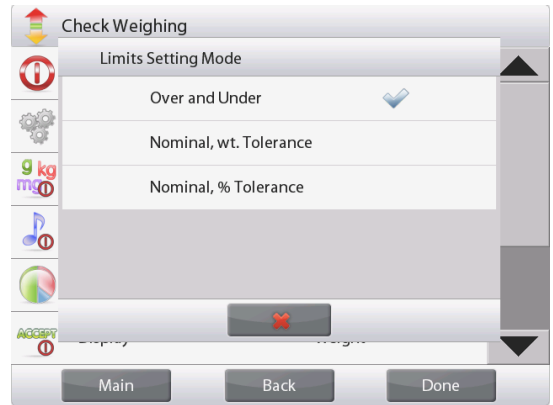

CHECK WEIGHING – Nominal/Wt Tolerance home screen

Main Display Line
Second Display Line (not shown)

Reference Fields

Application Buttons

Functions



Application Icon

To use this mode, touch **Edit Settings** to set the **Nominal**, and **Upper** and **Lower Tolerance** values (in weight).
(See keyboards below.)

Press **Return to Application** when settings are complete.

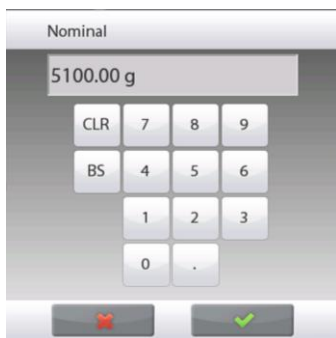

4.4.5 Check Weighing – Nominal/Percent Tolerance Mode

With this feature you can establish a Target or Nominal weight value and pre-set tolerance in percent.

To enable this feature, enter the **Setup** menu.



Change the mode to **Nominal, % Tolerance**. The Check Weighing options screen returns.

Press **Done** to begin Check Weighing.



The **CHECK WEIGHING – Nominal/Percent Tolerance** home screen

Main Display Line

Second Display Line (not shown)

Reference Fields

Application Buttons

Functions



Application Icon

To use this mode, touch **Edit Settings** to set the **Target Weight**, and **Upper** and **Lower Tolerance** values (in percent).
(See keyboards below.)

Press **Return to Application** when settings are complete.

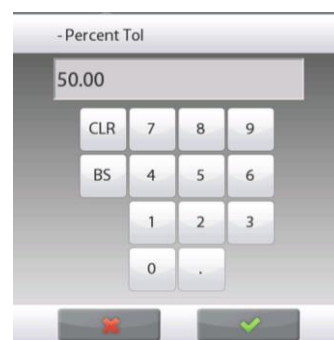
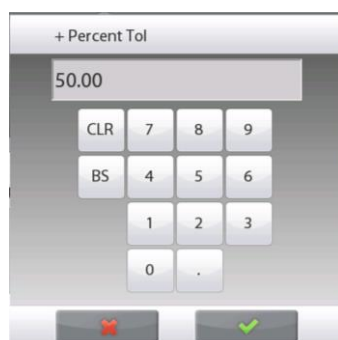
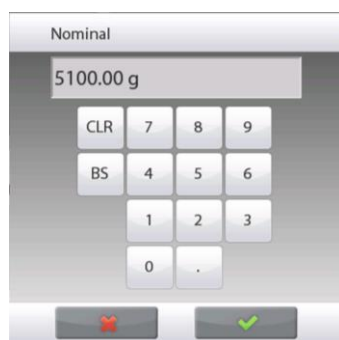

4.4.6 Display Settings

The results can be displayed with the check status (**Under**, **Accept**, or **Over**) either in the Progress bar (Weighing) or in the main Weighing Line (Check Status).

To display the results in the main Weighing Line, set the **Display Setting** to **Check Status**, using the Application Setup screen.

(The default value is Weight.)



The **CHECK WEIGHING** home screen with Display set to **Check Status**

Main Display Line
Second Display Line

Reference Fields

Application Buttons

Icon
Functions



Application

To enable **audible signals** for **Under**, **Accept**, and **Over**, Touch **Audible Signal-On** in the Application Setup screen.

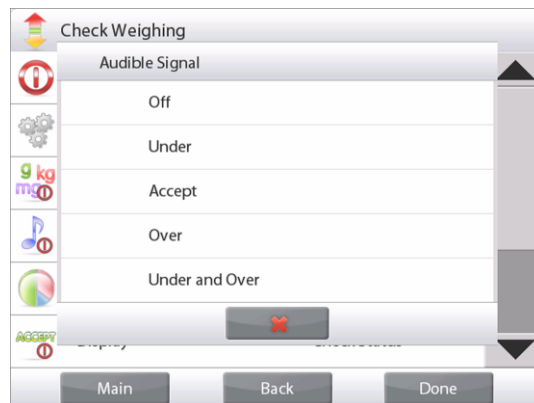

4.4.7 Statistics for Check Weighing

Use the Statistics function to compare a number of samples and examine the relative deviation of the samples along with other statistical data. A minimum of three samples is required.

Statistics can be determined **manually** (with key press after each step) or **automatically** (weights recorded automatically when stable). To use the statistics function, enable it first in the Application Setup menu.

Application Setup

First, Enable Statistics.



Touch the **Setup** Icon wrench to enter Setup menu.



Touch **Statistics**. Choose either **Manual** or **Automatic**, then press **Done**.

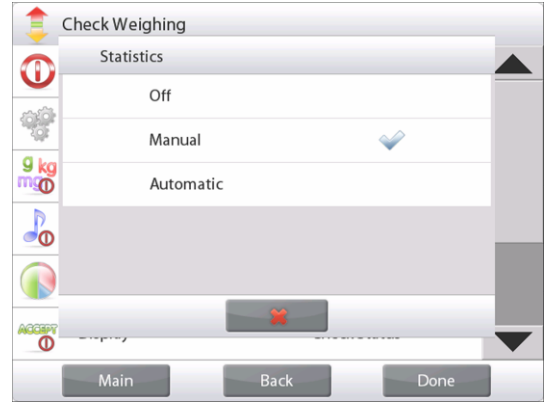

Accumulating Displayed Values & Viewing Data – Manual

Once Statistics is enabled, two buttons appear on the Application screen: **Statistics** and **Accumulate**.

To add the sample to the data set, place the item on the pan and press **Accumulate**.

When stable, the **Statistics** button momentarily lights to show the item is added to the set and the data set quantity increments by one.

Continue adding items and pressing **Accumulate** to build the statistical data set

At any time, press the **Statistics** button to view the results.



The **Statistics Results** screen

- Press **Print** to send to the enabled COM port
- Press **Close** to return to the Application home screen with the current statistics set.
- Press **Clear Data** to clear the results and return to the Application home screen.



Statistics – Automatic

Statistics Automatic mode is similar to manual mode (above) except the first stable weight is automatically captured. Thus the Accumulate button is not used.

4.5 Dynamic/Animal Weighing

Use this application to weigh an unstable load, such as a moving animal. Three different start/reset modes can be selected: Manual (start and stop via key press), **Semi-Automatic** (auto-start with manual reset), and **Automatic** (start and stop automatically).

Dynamic Weighing – Manual (default)

To set the mode, touch the Setup wrench:



When you make a selection, the Setup options screen re-appears.

Press **Done**.

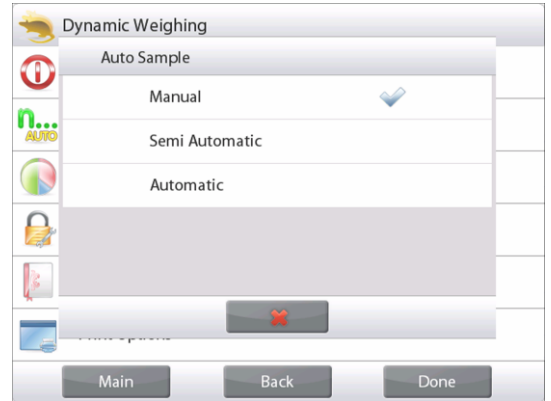

On the **Dynamic Weighing** home screen, the default (or last) Averaging Time is displayed.

Follow the screen instructions.



The **DYNAMIC WEIGHING** Home screen

Main Display Line
Second Display Line

Reference Fields

Application Buttons

Functions



Application Icon

Place objects on the pan.

Press the **Begin Dynamic** button.

The balance begins a countdown (averaging process).

During the countdown, the information line displays the time remaining.

If necessary, press Cancel to quit and return to the Home screen.



When the countdown ends, the result is displayed and held.

Press **Reset** to clear the held weight and return to the Initial screen.

Note: Clear the pan before beginning a new Dynamic Weighing cycle.



4.5.1 Edit Settings

To view or adjust the current settings:

Press the **Edit Settings** button.
 (See Home Screen, previous page.)
 The Settings screen appears.

The **Application Settings** Screen.

Settings available: **Averaging Time**

Functions Available: **Return to Application**

The Averaging Time can be set from 1 to 99 seconds.
 The default value is 10. To change it, press the button.

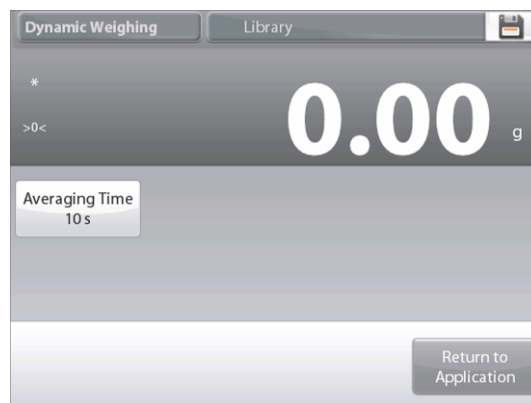

A numeric input window is displayed.

Key in the desired Averaging Time, then press **Done**.
 The display returns to the previous screen with the new value highlighted.

To return to the Dynamic Weighing home screen, touch **Return to Application**.



4.5.2 Application Setup

The Application can be customized for various user preferences.

Touch the Setup wrench to enter the Application Setup from the home screen.

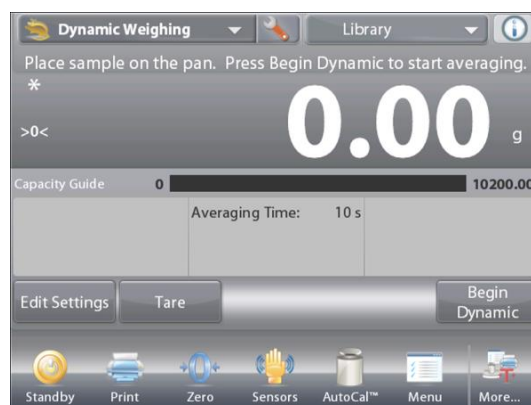

The **Setup** Menu appears.

Select the list item to view or change the setting as desired.

To return to the Application home screen, press **Done**.

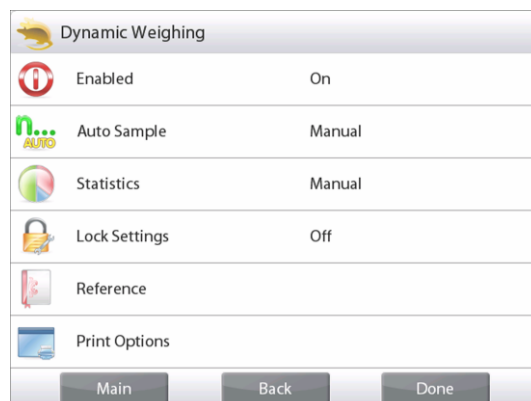

Dynamic Weighing Application Setups (defaults in Bold)

Item	Available Settings	Comments
Enabled	On , Off	Turns Application on/off
Auto Sample Mode	Manual , Semi Automatic Automatic	To select the Mode
Statistics	Off , Manual, Auto	
Lock Settings	On, Off	Press to lock the current setting(s) so they cannot be changed.
Reference fields		
Averaging Time	On , Off	Time in Seconds
Gross	On, Off	Gross weight is displayed
Net	On, Off	Net weight is displayed
Tare	On, Off	Tare weight is displayed
Print Options		
Averaging Time	On , Off	

4.5.3 Dynamic Weighing – Semi-Auto

The cycle begins when an object (animal) is placed on the pan, but the held value must be reset manually.

To enable this feature, touch the Setup Icon (wrench) in the top-center of the main screen to enter the **Dynamic Weighing Setup** menu.



Change the mode to **Semi Automatic**.

The **Dynamic – Semi-Automatic** screen appears with the default (or last) Averaging Time displayed.

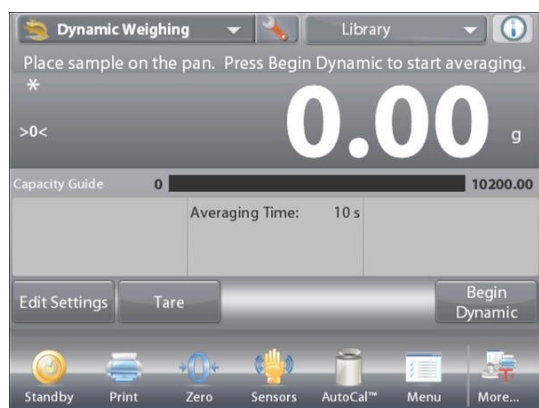

Place specimen on the Pan. The cycle starts automatically.

After the cycle ends, the weight reading is held. Press the **Reset** button to clear the reading and return to zero.



4.5.4 Dynamic Weighing – Automatic

The cycle begins when an object (animal) is placed on the pan, and the held value is automatically reset when the object is removed from the pan (10-second delay).

To enable this feature, enter the Dynamic Weighing Setup menu.



Press **Auto Sample**, and change the mode to **Automatic**.

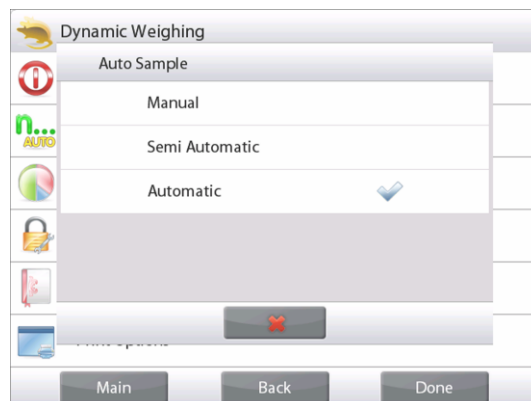

The **Dynamic – Automatic** screen appears with the default (or last) Averaging Time displayed.

Place objects on the pan to begin.

The cycle starts automatically.

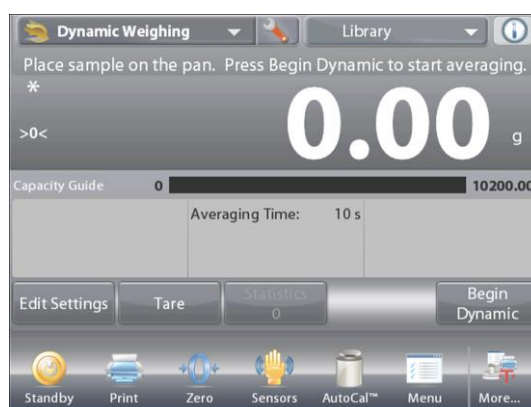

After the cycle ends, remove the specimen and the balance returns to the Home screen automatically (after a 10-second delay).

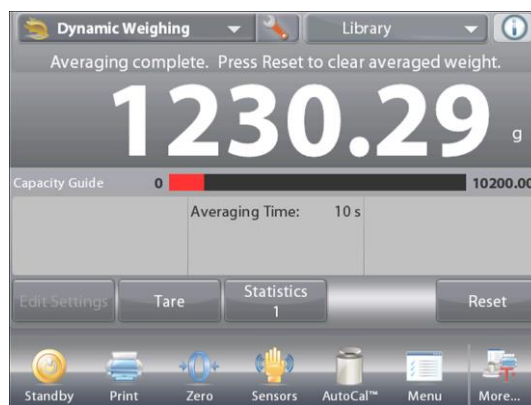

4.5.5 Statistics for Dynamic Weighing

Use the Statistics function to compare a number of samples and examine the relative deviation of the samples along with other statistical data. A minimum of three samples is required.

Statistics can be determined manually (**Manual** mode, with key press after each step) or automatically (**Automatic** Mode: weights are automatically recorded when stable). To use the statistics function, enable it first in the Application Setup menu.

Application Setup

First, Enable Statistics

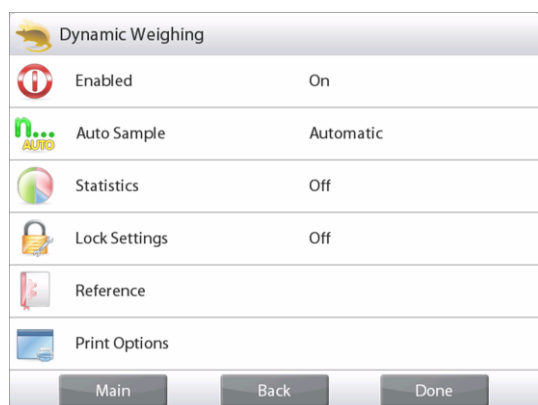

Touch the **Setup** Icon wrench to enter Setup menu.



Press **Statistics**. Choose either **Manual** or **Automatic** mode, then press **Done**.

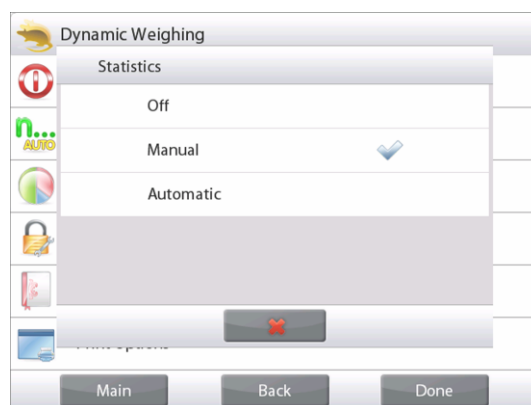

Accumulating Displayed Values & Viewing Data – Manual

Once Statistics is enabled, two buttons appear on the Application screen: **Statistics** and **Accumulate**.

To add the sample to the data set, place the item on the pan and press **Accumulate**.

When stable, the **Statistics** button momentarily lights to show the item is added to the set and the data set quantity increments by one.

Continue adding items and pressing **Accumulate** to build the statistical data set

At any time, press the **Statistics** button to view the results.



The **Statistics Results** screen

Press **Print** to send to the enabled COM port

Press **Close** to return to the Application home screen with the current statistics.

Press **Clear Data** to clear the results and return to the Application home screen.



Statistics – Automatic

Statistics Automatic mode is similar to manual mode (above) except the first stable weight is automatically captured. Thus the Accumulate button is not used.

4.6 Filling

This application allows the user to slowly fill a container to a pre-determined target weight. The progress bar displays the filling status, and within 10 percent of the target value the progress bar converts to fine resolution (+/- 10%) for accurate results.

In the upper left portion of the home screen, select **Filling**.

The default (or last) Target weight is displayed. Place objects on the pan to begin.



The **FILLING** Home screen

Main Display Line
Second Display Line

Reference Fields

Application Buttons

Functions



Application Icon

The progress bar displays the filling status, and within 10 percent of the target value, the progress bar converts to fine resolution display.

4.6.1 Edit Settings

To view or adjust the current settings:

Touch the **Edit Settings** button.

The Settings screen appears:

Settings available: **Target Weight**

Functions Available: **Recalculate Target Weight,**
Return to Application

Establish a Target Weight

Each time a new item is used for filling, the Target Weight (fill-to weight) must be established.

There are two (2) methods to establish the Target Weight:

1. The actual Target Weight is known; or
2. The Target Weight can be derived from a sample.

Establish using a Known Target Weight

The current Target Weight appears on the **Settings** screen, on the **Target Weight** button. (See above.)

To adjust the Target weight value directly, touch the **Target Weight** button.

A numeric input window appears.

Enter the desired Target Weight, then press ✓.

The display returns to the previous screen with the new value highlighted.

Press **Return to Application** to go to the **Filling** home screen.

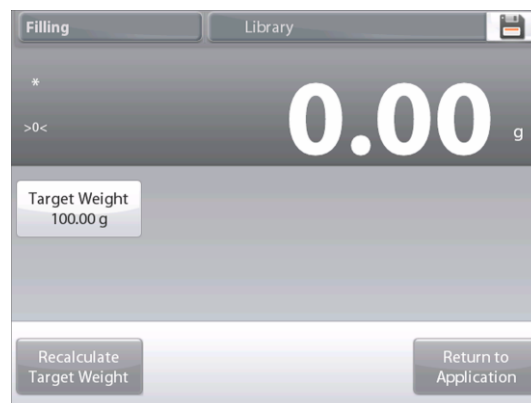

Using a Sample to establish new Target Weight – Derived

To establish a new Target Weight value, press the **Recalculate Target Weight** button.

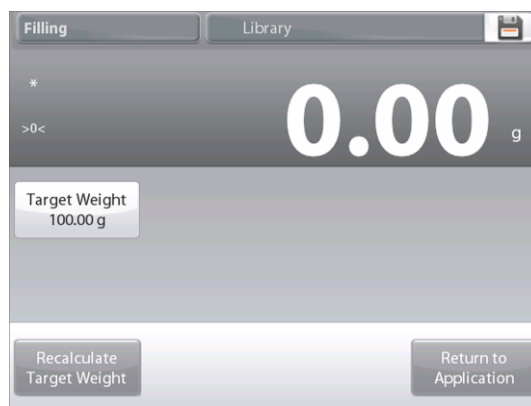

The New Target Screen appears, with a message:

Place the target weight on the pan. Press Accept to continue.

Place the weight on the pan (or in a tared container).

Press **Accept** to return to the Settings screen.

The display returns to the Settings screen with the new Target Weight value highlighted momentarily.

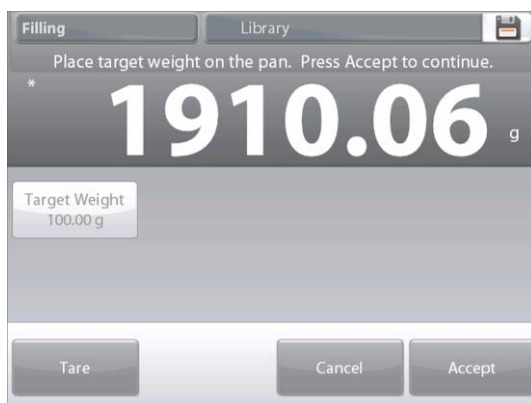

To return to the Filling home screen, touch **Return to Application**.

4.6.2 Application Setup

The Application can be customized for various user preferences.

Touch the **Setup** Icon (wrench) to enter the Application Setup menu from the home screen.



The Setup Menu appears.

Select the list item to view or change the setting as desired.

To return to the Application home screen, touch **Done**.

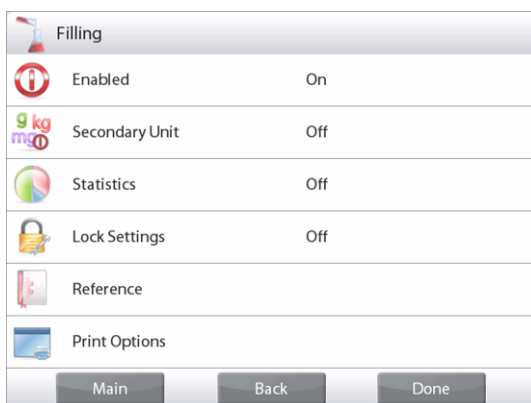

The Filling Application Setups (defaults in Bold)

Item	Available Settings	Comments
Enabled	On , Off	Turns Application on/off
Secondary Unit	On, Off	To show the Second Display line
Statistics	Off , Manual, Auto	
Lock Settings	On, Off	Press to lock the current setting(s) so they cannot be changed.
Reference fields		
Target Weight	On , Off	The Target weight is displayed
Difference (Weight)	On , Off	Displays the Difference to the Target weight
Difference (Percent)	On , Off	Displays the Difference to the Target weight
Gross	On, Off	Gross weight is displayed
Net	On, Off	Net weight is displayed
Tare	On, Off	Tare weight is displayed
Print Options		
Target Weight	On , Off	
Difference (Weight)	On , Off	
Difference (Percent)	On , Off	

4.6.3 Statistics for Filling

Use the Statistics function to compare a number of samples and examine the relative deviation of the samples along with other statistical data. A minimum of three samples is required.

Statistics can be determined manually (**Manual** mode, with key press after each step) or automatically (**Automatic** Mode: weights are automatically recorded when stable). To use the statistics function, enable it first in the Application Setup menu.

Application Setup

First, Enable Statistics



Touch the Setup Icon wrench (see below) to enter Setup menu.



Touch **Statistics**. Choose either **Manual** or **Automatic** mode, then press **Done**.

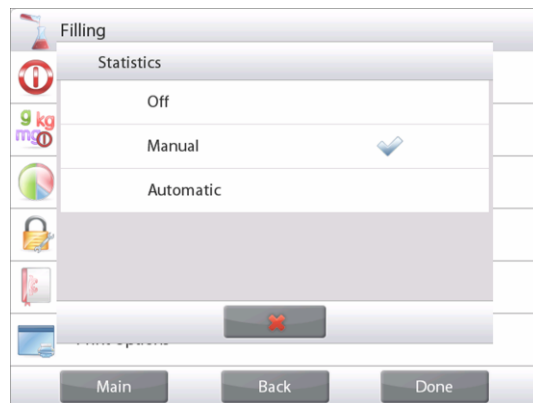

Accumulating Displayed Values & Viewing Data – Manual

Once Statistics is enabled, two buttons appear on the Application screen: **Statistics** and **Accumulate**.

To add the sample to the data set, place the item on the pan and press **Accumulate**.

When stable, the **Statistics** button momentarily lights to show the item is added to the set and the data set quantity increments by one.

Continue adding items and pressing **Accumulate** to build the statistical data set.

At any time, press the **Statistics** button to view the results.



The **Statistics Results** screen

Press **Print** to send to the enabled COM port

Press **Close** to return to the Application home screen with the current statistics set.

Press **Clear Data** to clear the results and return to the Application home screen.

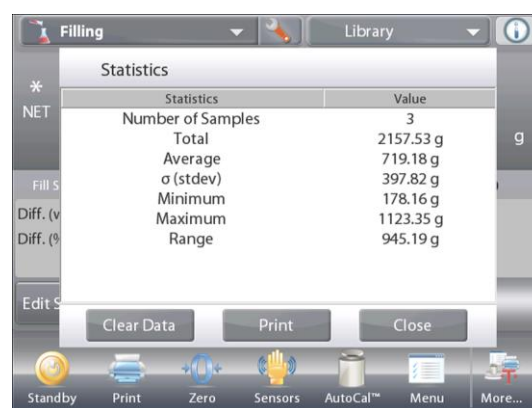

Statistics – Automatic

Statistics Automatic mode is similar to manual mode (above) except the first stable weight is automatically captured. Thus the Accumulate button is not used.

4.7 Totalization

Totalization measures the cumulative weight of a sequence of items. Two different Totalization accumulation modes can be selected: **Manual** accumulation (requires key press) and **Automatic** accumulation. The cumulative total may exceed the capacity of the Balance.

4.7.1 Totalization – Manual (Default)

Touch the upper left portion of the home screen. A drop-down menu appears. Select **Totalization** if it is present. (If not, touch the **Menu** icon in the bottom-left corner, then choose **Application Modes**, scroll down to find **Totalization**, press it, then press **Enabled** to turn it **On**. It will now appear in the Application Modes menu on the home screen.

Place objects on the pan to begin.



The **TOTALIZATION** Home screen

Main Display Line
Second Display Line

Reference Fields

Application Buttons

Functions



Application Icon

The sample weight is shown on the Main Display Line. Press **Accumulate** to add the weight of the item to the total. When stable, the new total is shown on the secondary Display Line. Remove the item from the weighing pan, then add the next item and continue as above. When finished, press the **Clear Total** button to reset the Second Display Line to zero.



4.7.2 Application Setup

The Application can be customized for various user preferences.

Touch the Setup Icon (wrench) to enter the Application Setup from the home screen.

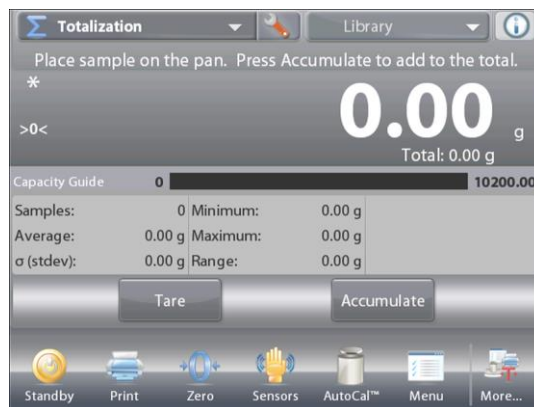

The Setup Menu appears.

Select the list item to view or change the setting as desired.

To return to the Application home screen, touch **Done**.

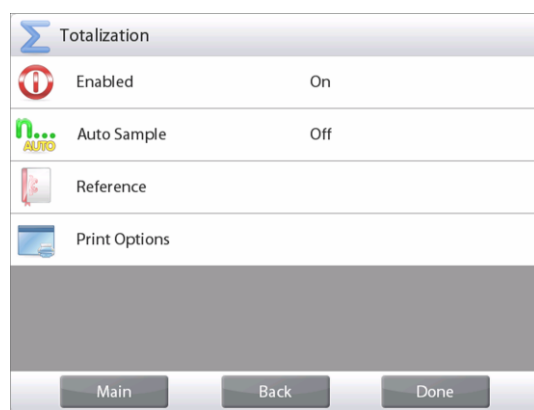

The Totalization Application Setups (defaults in **Bold**)

Item	Available Settings	Comments
Enabled	On , Off	Turns Application on/off
Auto Sample Mode	On, Off	To select the mode
Reference fields		
Samples	On , Off	To display the number of samples weighed
Average (weight)	On , Off	Displays the Average
Standard deviation	On , Off	Displays the standard deviation
Minimum (weight)	On , Off	Displays the Minimum value
Maximum (weight)	On , Off	Displays the Maximum value
Range	On , Off	Displays the Range
Gross	On, Off	Gross weight is displayed
Net	On, Off	Net weight is displayed
Tare	On, Off	Tare weight is displayed
Print Options		
See Printing Section.		
Samples	On , Off	
Average (weight)	On , Off	
Standard Deviation	On , Off	
Minimum (weight)	On , Off	
Maximum (weight)	On , Off	
Range	On , Off	

4.7.3 Totalization – Automatic

The weight of the item is added automatically (when stable).

To enable this feature:

1. Touch the Setup Icon (wrench) to enter Application Setup.



2. Press **Auto Sample** to turn this feature **On**.

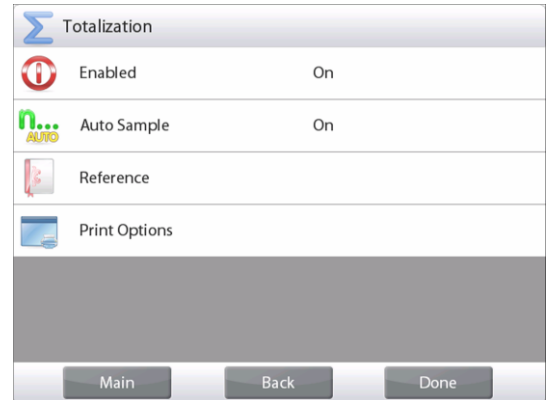

Clear the pan (if necessary). Add a new sample.
The item weight is shown on the Main Display Line.

The weight of the item is automatically added (when stable) to the total. The new total is shown on the Second Display Line.

Remove the item from the weighing pan, then add the next item and continue the same as in manual mode.

When finished, press the **Clear Total** button to reset the Second Display line to zero.



4.8 Formulation

Use this application for compounding and recipe making. The number of components can be 2 to 99. Formulation has two available modes of operation: **Free Formulation** and **Recipe Formulation**.

4.8.1 Free Formulation (default)

This mode of Formulation allows the user to freely add components. A filler material is asked for at the end. In the upper left portion of the home screen, select **Formulation**.



The **FREE FORMULATION** Home screen

Main Display Line
Second Display Line

Reference Fields

Application Buttons

Functions



Application Icon

To start the compounding process, press **Begin Formulation**.

A prompt says **Place component 1 then press Accept**.

The item weight is displayed on the main display Line.

Place the first ingredient on the pan (or in a tared container).

Press **Accept** to store the first component.

A prompt says **Place item 2. Press Accept**.

Continue adding components and pressing **Accept** to store the weight of the individual components until the formula is complete.

The **Total** line shows the total weight of all the components.

Press **Print** at any time in the process to print the recipe.



Then press **End Formula**.

The display may prompt for a Filler material.

If the formula calls for a filler material, press **OK**.

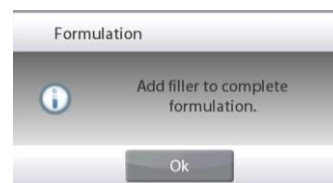

A popup message window appears, prompting for the Filler Material to be added.

Add the filler if needed, then press **Accept**.

(If no filler is needed, press **Accept** *without* adding filler.)

The results are then displayed in a pop-up window.

Free Formulation Results

Press **Print** to send data to the enabled COM port

Press **Close** to close the Results window and return to the Application home screen

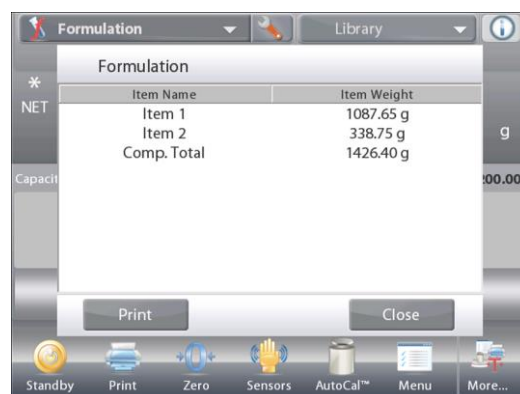

4.8.2 Application Setup

The Application can be customized for various user preferences.

Touch the **Setup** icon (wrench) to enter **Application Setup** from the home screen.

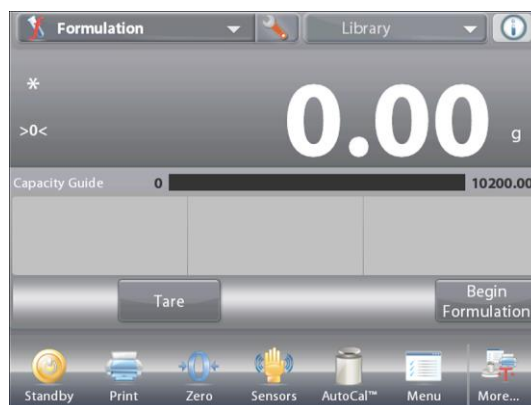

The **Setup Menu** appears.

Select the list item to view or change the setting as desired.

To return to the Application home screen, touch **Done**.



The Formulation Application Setups (defaults in **Bold**)

Item	Available Settings	Comments
Enabled	On , Off	Turns Application on/off
Mode	Free Formulate , Recipe Based	To select the mode
Filler	On, Off	To prompt for a filler material
Secondary Unit	On, Off	To show the Second Display line
Reference fields		
Total	On , Off	Total is displayed
Gross	On, Off	Gross weight is displayed
Net	On, Off	Net weight is displayed
Tare	On, Off	Tare weight is displayed
Target	On , Off	For Recipe Based mode
Difference (weight)	On , Off	For Recipe Based mode
Difference (percent)	On , Off	For Recipe Based mode
Print Options		
Total	On , Off	
Target	On , Off	For Recipe Based mode
Difference (weight)	On , Off	For Recipe Based mode
Difference (percent)	On , Off	For Recipe Based mode

4.8.3 Recipe Formulation

Recipe Formulation requires the formula to be entered first, followed component by component.

To enable this feature, press the Setup icon (wrench) to enter the Formulation Setup menu.



Change the mode to **Recipe Based**. Press **Done** in the main setup options screen.

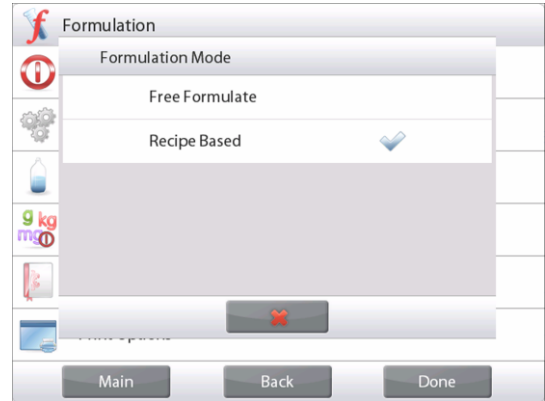

The **RECIPED FORMULATION** Home screen

Main Display Line
Second Display Line

Reference Fields

Application Buttons

Functions



Application Icon

Press **Begin Formulation**.

If no items have been previously set up, the Settings screen appears.

If items already exist in memory, Formulation begins.

Press the **Add New** button.

A new default component is added to the end of the Formula (default Name, Weight).



To change the default component Name, Press **Edit Name**.

The alpha-numeric entry screen appears.



Enter the new name, then press ✓.

The display returns to the previous screen with the new value highlighted momentarily.

Item #	Item Name	Item Weight
1	Item 1	100.00 g
2	Item 2	100.00 g
3	calcium	100.00 g

Buttons: Add New, Edit Name, Edit Weight, Delete Item, Move Up, Move Down, Clear All, Return to Application

To change the default component weight, press **Edit Weight**.

The numeric entry screen appears.

Enter the new weight, then press ✓.

Edit Name

calcium

1 2 3 4 5 6 7 8 9 0
q w e r t y u i o p
a s d f g h j k l
↑ z x c v b n m . ←

✖ ✓

Formulation Library

Item #	Item Name	Item Weight
1	Item 1	100.00 g
2	Item 2	100.00 g
3	calcium	100.00 g

Edit Weight

20 g

CLR 7 8 9
BS 4 5 6
1 2 3
0 .

✖ ✓

Return to Application

The display returns to the previous screen with the new value highlighted momentarily.

Continue adding components as required for your formula.

To change the order of a component in the formula, touch the item to highlight it, then press **Move Up** or **Move Down**.

To delete a component, touch the item to highlight it, and press **Delete Item**.

To clear all components, press **Clear All**. A confirmation is required.

When finished, press **Return to Application**.

Item #	Item Name	Item Weight
1	Item 1	20.00 g
2	Item 2	100.00 g
3	calcium	100.00 g

Buttons: Add New, Edit Name, Edit Weight, Delete Item, Move Up, Move Down, Clear All, Return to Application

Press **Begin Formulation**. Follow the screen instructions:

Add the required component in the formula.

The component weight is shown on the Main Display Line.

The progress bar displays the fill status. Within 10 percent of the target value the progress bar converts to fine resolution display.

Press **Accept** to add the weight of the component to the total. The new total appears on the Second Display Line.

The Difference to the target is displayed for each component (in weight and percent).

Follow the screen instructions to continue adding components and pressing **Accept** to complete the Formula.

When finished, the Formulation Results screen is displayed.

Formulation Library

Step 1: Place 20.00 g Item 1 Press Accept.

* **499.33** g

Fill Status 90 110 2496.7%

Diff. (wt.): 479.33 g Target: 20.00 g
Diff. (%): 2396.7 %

Item Settings Tare Cancel Accept

Standby Print Zero Sensors AutoCal™ Menu More...

Formulation Results

Press **Print** to send the results to the enabled COM port.

To close the Results window and return to the Application home screen, press **Close**.

Formulation			
Item Name	Target	Actual	Diff. (%)
Item 1	20.00 g	499.33 g	2396.7 %
Item 2	100.00 g	784.61 g	684.6 %
calcium	100.00 g	820.13 g	720.1 %
Comp. Total	220.00 g	2104.07 g	856.4 %

4.9 Differential Weighing

Differential weighing stores weight values so samples can be dried or processed and the difference in weight calculated. Up to 99 samples can be stored.

Differential weighing has two operating modes:

- **Auto-Process On**, where the initial and final weights are sequentially gathered for a set of items, with no need to return to Item Settings.
- **Auto-Process Off**, where initial and final weights are gathered separately for each item, after each item is selected in Item Settings.

Touch the **Setup** icon (wrench) to enter **Application Setup** from the home screen.

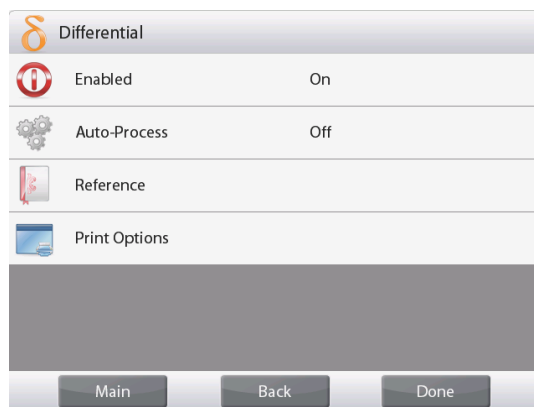

The **DIFFERENTIAL WEIGHING** Home screen

Main Display Line
Second Display Line

Reference Fields

Application Buttons

Functions



Application Icon

4.9.1 Item Settings

Press **Item Settings** to set up items in memory.

To set up the item, **Press Add New**.

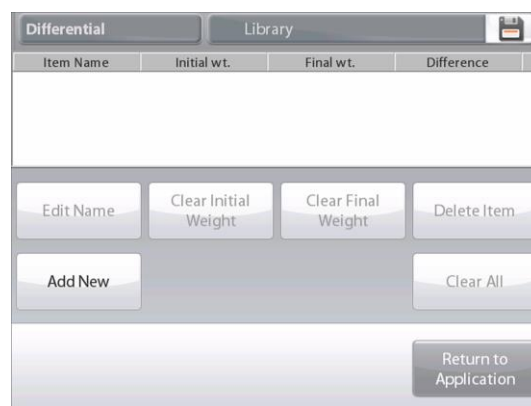

New items are added with default name and weight information (no initial or final weights).

To change the default Item Name, press **Edit Name**.

The alpha-numeric entry screen appears.

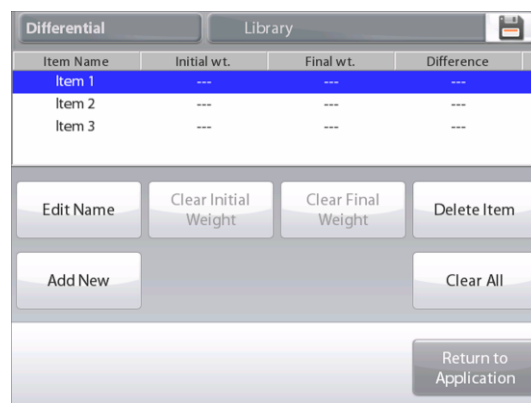

Enter the new name, then press ✓.
 The display returns to the previous screen with the new value highlighted momentarily.



Continue adding items as required using **Add New**.
 New items can be added at any time.

To delete an item, touch the item to highlight it,
 then press **Delete Item**.

To Clear the item initial weight press **Clear Initial Weight**.
 (This feature is disabled if no initial weight is stored.)

To Clear the item's final weight, press **Clear Final Weight**.
 (This feature is disabled if no final weight is stored.)

To clear all items, press **Clear All**, then confirm.

When finished, press **Return to Application**.

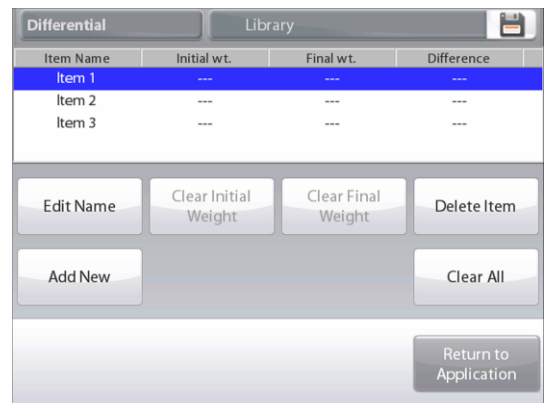

On the main Application screen, follow the screen instructions:
 Add the first item, then press **Accept** to store the value.

The initial weights of the defined item are recorded first, then
 the final weights of the items are collected next.

Once the item's initial weight and a final weight are stored, the
 values are displayed along with the Difference in weight and
 percent.

The items are stored in memory. To begin a new Differential
 weighing session, delete the initial and/or final weights.



4.9.2 Application Setup

The Application can be customized for various user preferences.

Touch the **Setup** icon (wrench) to enter **Application Setup** from the home screen.



The **Setup** Menu appears.

Select the list item to view or change the setting as desired.
To return to the Application home screen, touch **Done**.

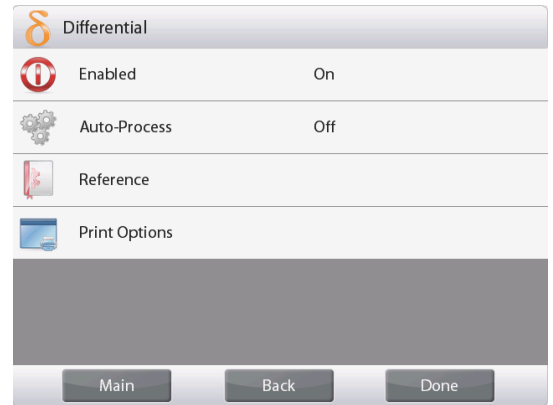

The Differential Weighing Application Setups (defaults in **Bold**)

Item	Available Settings	Comments
Enabled	On , Off	Turns Application on/off
Auto-Process Mode	On , Off	To select the mode
Reference fields		
Initial Weight	On, Off	The initial weight is displayed
Final Weight	On , Off	The final weight is displayed
Difference (Weight)	On , Off	Displays the Difference to initial in weight
Difference (Percent)	On , Off	Displays the Difference to initial in percent
Gross	On, Off	Gross weight is displayed
Net	On, Off	Net weight is displayed
Tare	On, Off	Tare weight is displayed
Print Options		See Printing Section.
Initial Weight	On , Off	
Final Weight	On , Off	
Difference (Weight)	On , Off	
Difference (Percent)	On , Off	

4.9.3 Differential Weighing with Auto-Process On

Differential weighing with Auto Process On requires the initial and final weights to be sequentially gathered for a single item.

To enable this feature, touch the **Setup** icon (wrench) from the home screen to enter **Application Setup**.



Press **Auto Process** to turn it **On**.

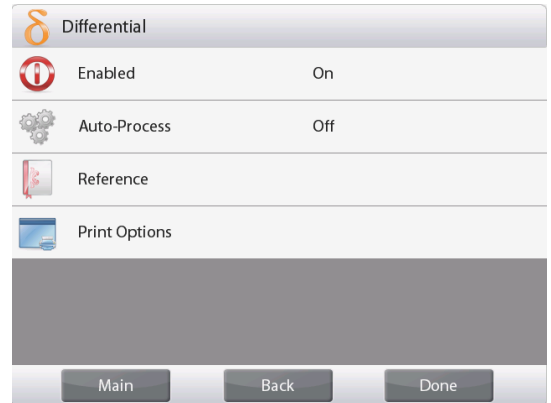

Follow the screen instructions to begin.



The **DIFFERENTIAL WEIGHING – Auto** Home screen

Main Display Line
Second Display Line (not shown)

Reference Fields

Application Buttons

Functions



Application Icon

Follow the screen instructions:

Press **Item Settings** to set up items in memory if necessary.

Use the buttons as necessary.

Follow the same steps as shown on page 57.

Press **Return to Application** when ready.

A message prompts for Item 1 to be placed on the pan again, then to press **Accept to establish Final Weight**.

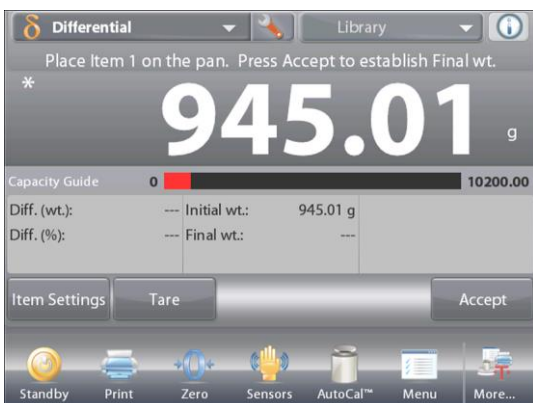
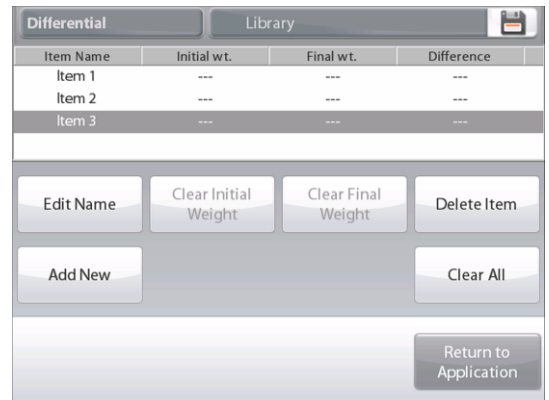

After **Accept** is pressed, the difference between initial and final weights appears in the Reference Fields.

A message prompts to start the process again, if desired.



4.10 Density Determination

The Explorer can be used to determine an object's density. Four types of density determination can be made:

1. Solids *more* dense than water
2. Solids *less* dense than water
3. Liquid density
4. Porous material (impregnated with oil)

A density determination kit is designed to be used with Ohaus Explorer balances. Illustrations in this procedure refer to the density kit. However, you may use whatever lab apparatus that suits the requirements for density measurements. The balance software includes a built-in reference density table for water at temperatures between 10°C and 30°C. Review this entire section before attempting density measurements.

When making density measurements the material should weigh at least 10 mg on an analytical balance and 100 mg on a precision balance.

Density can be determined **manually** (with a key press after each step) or **automatically** (weights are automatically recorded). Before making density measurements, establish the Application Settings.



The **DENSITY DETERMINATION** Home screen

Main Display Line
Second Display Line (not shown)

Reference Fields

Application Buttons

Functions



Application Icon

4.10.1 Measuring the Density of a Solid Using Water (default)

Press the **Setup** button (the wrench) to open the Density Determination **Settings** screen.



Confirm the following **Setups** are selected:

- ✓ **Density Type: Solid**
- ✓ **Liquid Type: Water**
- ✓ **Porous Material: Off**

Press **Done** to return to the Density Determination home screen.

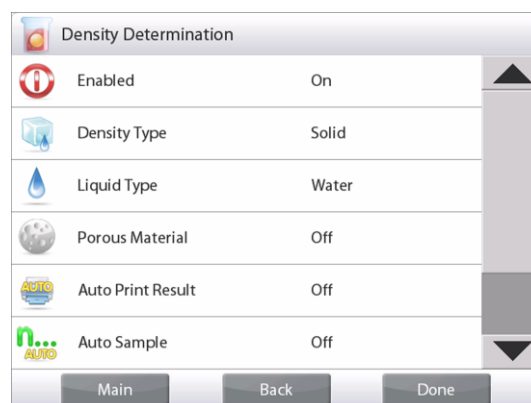

The **Edit Settings** Screen.

Settings available: **Water Temp**

Functions Available: **Return to Application**

To adjust the water temperature value, touch the **Water Temp** button.

The balance calculates water density based on the water temperature value entered (internal lookup table).

Measure the actual water temperature using a precision thermometer.

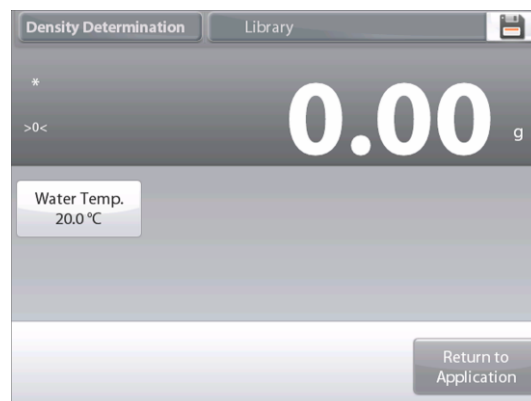

A numeric input window appears.

Enter the actual water temperature, then press **Done**.

The display returns to the previous screen with the new value highlighted.

To return to the Density Determination home screen, touch **Return to Application**.

To begin the Density Determination process, press **Begin Density Determination**.

(See below.)

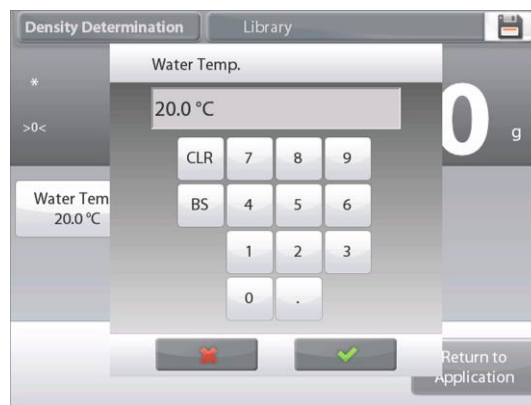

Step 1 of 2 – Weigh the Sample in Air. Press **Begin Density Calculation**. Follow screen instructions, then press **Accept** to store the dry sample weight (“in air”).

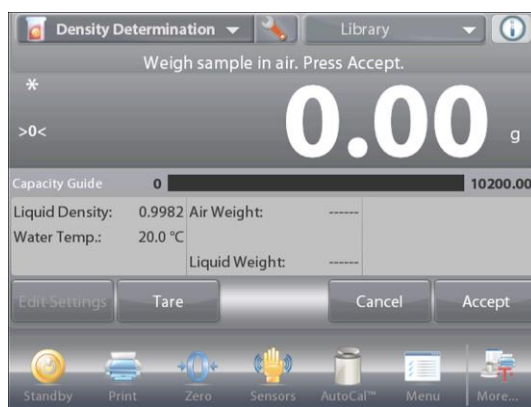

Step 2 of 2 – Weigh the Sample Submerged in the Liquid. Follow the screen instructions, then press **Accept** to store the sample weight (submerged in liquid).



Once the necessary weights have been determined, the density of the sample is displayed in **g/cm³** (along with the weight in air, weight in water) on the Application screen.

Press **Begin Density Determination** to reset all the weight values and restart the process.

4.10.2 Application Setup

The Application can be customized for various user preferences.

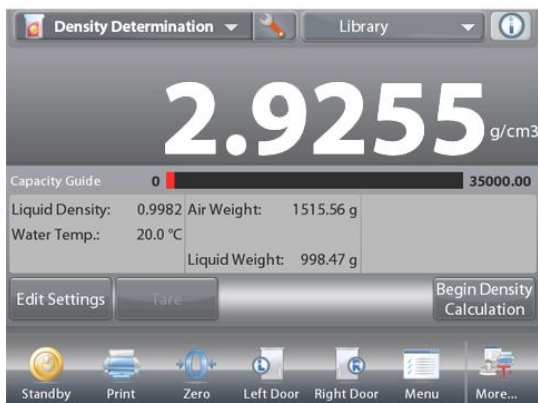

Touch the **Setup** Icon (wrench) to enter Application Setup from the home screen.

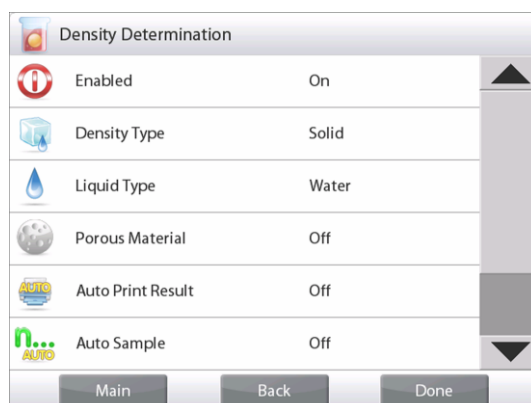

The **Setup Menu** appears.

Select the list item to view or change the setting as desired.

To return to the Application home screen, touch **Done**.

The Density Application Setups (defaults in Bold)

Item	Available Settings	Comments
Enabled	On , Off	Turns Application on/off
Density Type	Solid , Liquid	To select either solid or liquid
Liquid Type	Water , Other	Liquid used during measurements
Porous Material	On, Off	To select Porous material
Auto Print Result	On, Off	To automatically print results
Auto Sample Mode	On, Off	To select the mode
Reference fields		
Liquid Density	On , Off	Test liquid's density is displayed
Water Temperature	On , Off	The water temp is displayed
Oil density	On , Off	The test oil's density is displayed
Weight in Air	On , Off	The sample weight is displayed
Oiled Weight	On , Off	The sample weight is displayed
Weight in Liquid	On , Off	The sample weight is displayed
Sinker volume	On , Off	Displays volume of the Sinker
Print Options		
Porous Material	On , Off	
Liquid Type	On , Off	
Liquid Density	On , Off	
Water Temperature	On , Off	
Weight in Air	On , Off	
Weight in Liquid	On , Off	

4.10.3 Measuring the Density of a Buoyant Material Using Water

Press the **Setup** button (the wrench) to open **Settings** screen.

Confirm the following **Setups** are selected:

- ✓ **Density Type: Solid**
- ✓ **Liquid Type: Water**
- ✓ **Porous Material: Off**

Press **Done** to return to the Density Determination home screen.

Follow the same procedure as Solid Material above, except in Density Determination step 2, **push the sample down** into the liquid until it is fully submerged.

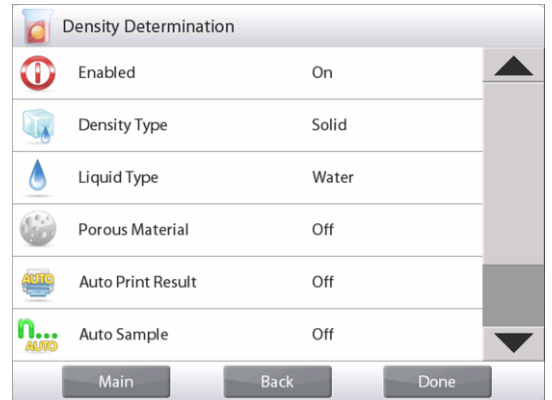

4.10.4 Measuring the Density of a Solid Using an Auxiliary Liquid

To enable this feature, enter the Density Setup menu and select the following:

Density Type: Solid; Liquid Type: Other; Porous Material: Off. (See Application Setup.)



The **DENSITY DETERMINATION – SOLID** Home screen

Main Display Line
Second Display Line

Reference Fields

Application Buttons

Functions



Application Icon

Confirm the default values displayed (Liquid Density, etc) are correct.

To edit the default values, touch **Edit Settings** and the application Settings screen appears.

Settings available: Liquid Density

Functions Available: Return to Application

To adjust the Liquid Density value, touch the **Liquid Density** button.

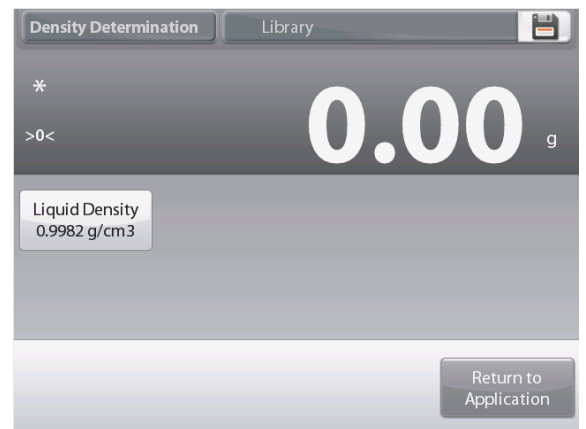

Measure the actual liquid density of the Density setup and enter it.

A numeric input window appears.

Key in the density in g/cm³, then press ✓.

The display returns to the previous screen with the new value highlighted.

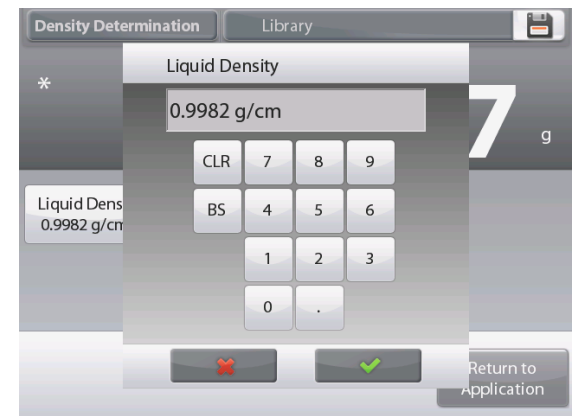

To return to the Density Determination home screen, touch **Return to Application**.

Begin the Density determination process as per above.

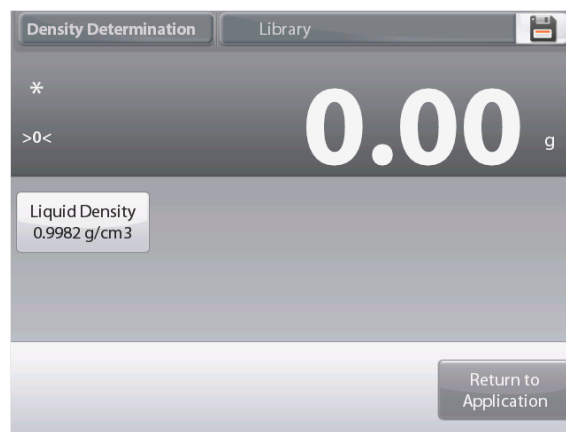

4.10.5 Measuring the Density of a liquid using a Calibrated Sinkers (not supplied)

Enable this feature, enter the Density Setup menu and select the following; **Density Type: Liquid**. (See Application Setup.)

Note: when the Density Type is set to Liquid, the Liquid type and Porous material selections are disabled.



The **DENSITY DETERMINATION – LIQUID** Home screen

Main Display Line
Second Display Line

Reference Fields

Application Buttons

Functions



Application Icon

Confirm that the default value displayed (sinker volume) is correct. To edit the default values, touch **Edit Settings** and the Settings screen is now displayed:

Settings available: **Sinker Volume**

Functions Available: **Return to Application**

To adjust the Sinker volume value, touch the **Sinker Volume** button.

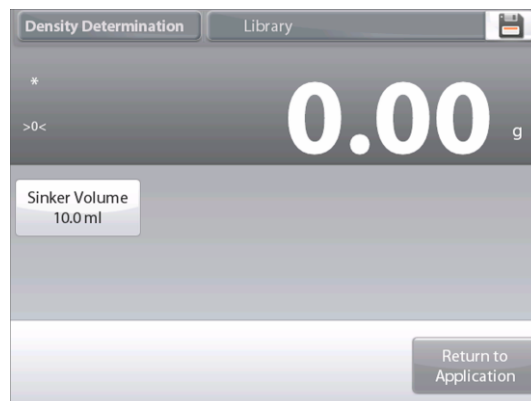

A numeric input window is displayed.

Key in the desired value, then press ✓.

The display returns to the previous screen with the new value highlighted.

To return to the Density Determination home screen, touch **Return to Application**.

Press **Begin Density Determination** to start the process.



Step 1 of 2 – Weigh the Sinker in Air.

Follow the screen instructions, then press **Accept** to store the sinker weight (“in air”).

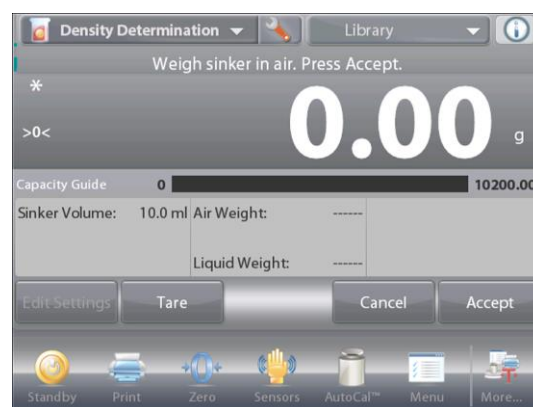

Step 2 of 2 – Weigh the Sinker Submerged in the Test Liquid.

Follow the screen instructions, then press **Accept** to store the sinker weight (submerged in liquid).

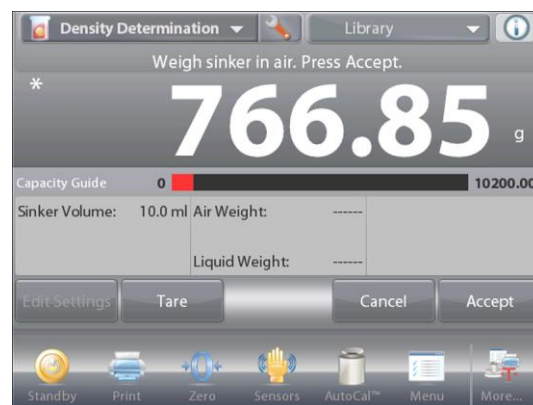

Once the necessary weights have been determined, the density of the Liquid sample is displayed in g/cm^3 (along with the weight in air, weight in water) on the Application screen.

Press **Begin Density Determination** to reset all the weight values and restart the process.



4.10.6 Measuring the Density of Porous Material Using Oil

To enable this feature, enter the Density Determination Setup menu, and set the following:

- ✓ **Density Type: Solid**
- ✓ **Liquid Type: Water**
- ✓ **Porous Material: On**

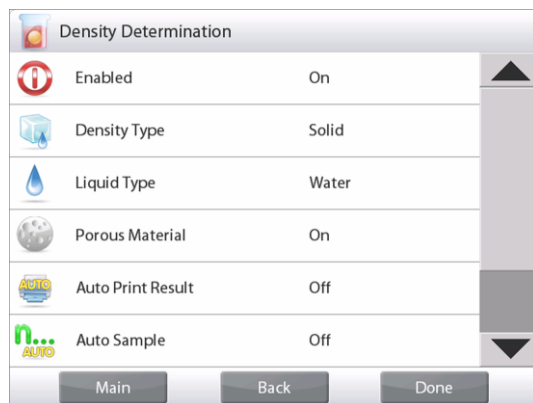

The DENSITY DETERMINATION – POROUS Home screen

Main Display Line
Second Display Line

Reference Fields

Application Buttons

Functions



Application Icon

Confirm the default values displayed (Water Temp) are correct.

To edit the default values, touch **Edit settings**.

The Settings screen appears.

Settings available: **Water Temp, Oil Density**

Functions Available: **Return to Application**

The balance calculates water density based on the water temperature value entered (look-up table).

Measure the actual water temperature using a precision thermometer.

To adjust the Water Temperature or Oil Density values, touch the **Water Temp** or **Oil Density** button.

Numeric input windows appear.

Key in the desired value, then press ✓.

The display returns to the previous screen with the new value highlighted.

To return to the Density Determination home screen, touch **Return to Application**.

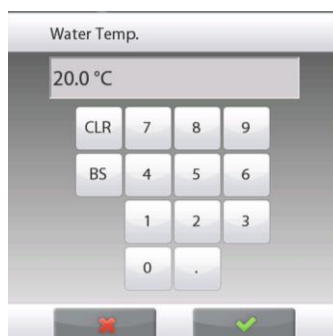
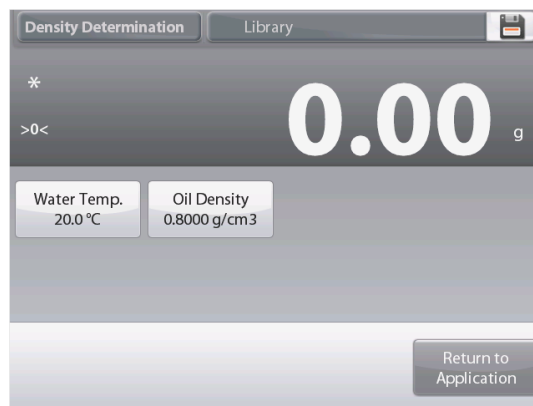

Press **Begin Density Calculation**.

Step 1 of 3 – Weigh the Un-Oiled Sample in Air.

Follow the screen instructions then press **Accept** to store the dry sample weight (in air).

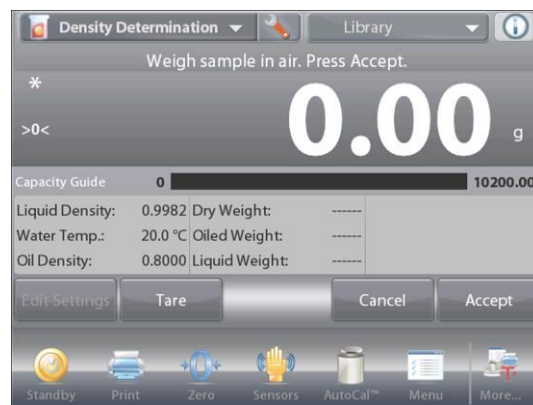

Step 2 of 3 – Weigh the Oiled Sample in Air.

Follow the screen instructions then press **Accept** to store the sample weight (oiled).

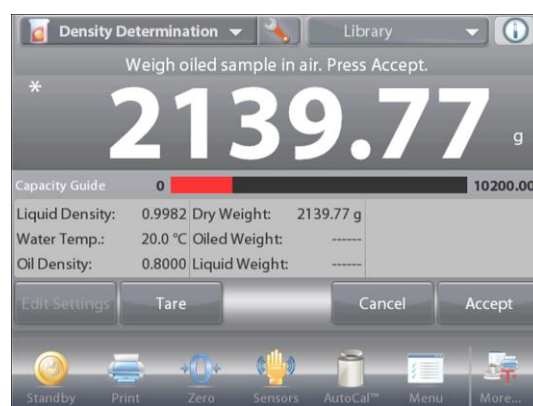

Step 3 of 3 – Weigh the Oiled Sample Submerged in Liquid.

Follow the screen instructions then press **Accept** to store the oiled sample weight (submerged in liquid).



Once the necessary weights have been determined, the density of the sample is displayed in **g/cm³** (along with the weight in air, un-oiled and oiled, and weight in water) on the Application screen

The value stays on the display until **Begin Density Determination** is touched.

Press **Begin Density Determination** to reset all the weight values and restart the process.



4.11 Peak Hold

The Peak Hold application allows the user to capture and store the highest stable or unstable weight in a series of weight measurements.

Three different start/reset modes can be selected:

- ✓ **Manual** (start and stop the capture via key press),
- ✓ **Semi-Automatic** (start automatically/reset manually); and
- ✓ **Automatic** (start and stop the capture automatically).

This application allows both stable and unstable weights to be captured.

4.11.1 Peak Hold – Semi-Automatic (default)

In the upper left portion of the home screen, select **Peak Hold**. Follow the screen instructions to begin.



The **PEAK HOLD** Home screen

- Main Display Line
- Second Display Line
- Reference Fields
- Application Buttons
- Functions



Application Icon

Place item on the pan. The capture process starts automatically.
 The highest reading is held on the display.
 To release the reading, press **End Peak Hold**.
 The following screen appears.



Clear the pan or press **Tare** to reset the display and re-start the process.



4.11.2 Application Setup

The Application can be customized for various user preferences.

Touch the **Setup** icon (wrench) to enter **Application Setup** from the home screen.

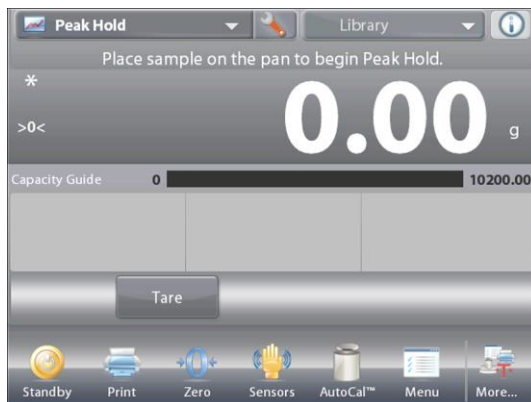

The **Setup Menu** appears.

Select the list item to view or change the setting as desired.

To return to the Application home screen, touch **Done**.

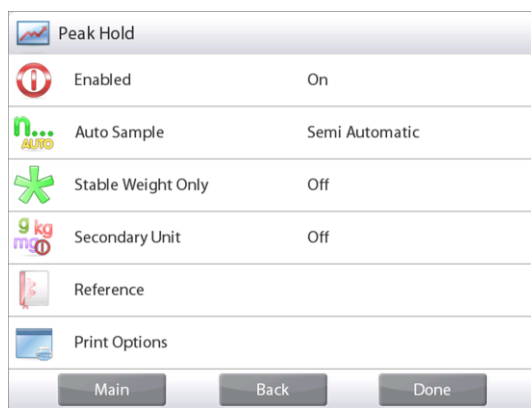

The **Peak Hold Application Setups** (defaults in Bold).

Item	Available Settings	Comments
Enabled	On , Off	Turns Application on/off
Auto Sample Mode	Manual, Semi Automatic , Automatic	To select the mode of operation
Stable Weight Only	On, Off	To capture Stable values only
Secondary Unit	On, Off	To show the Second Display line
Reference fields		
Gross	On, Off	Gross weight is displayed
Net	On, Off	Net weight is displayed
Tare	On, Off	Tare weight is displayed
Print Options		
Stable Weight Only	On , Off	

4.11.3 Peak Hold – Manual

For manual start and reset, choose **Manual** mode.

To enable this feature, enter the Peak Hold **Setup** menu:



Change the mode to **Manual**.

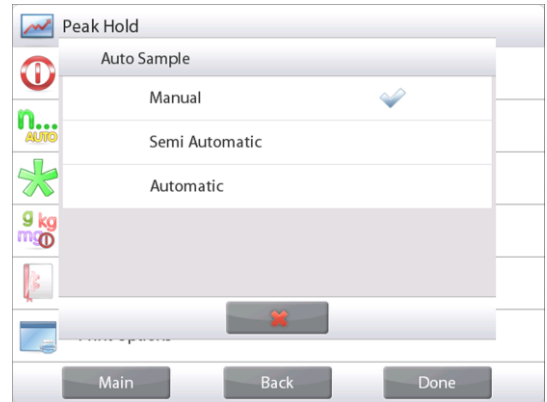

The **PEAK HOLD** – Manual Home screen

- Main Display Line
- Second Display Line
- Reference Fields
- Application Buttons
- Functions



Application Icon

Follow the screen instructions: Place item on the pan.
 Press **Begin Peak Hold** to begin the capture process.
 The following screen appears:



The highest stable weight reading is held indefinitely.
 Press **End Peak Hold** then clear the pan to reset the display
 and re-start the process.



4.11.4 Peak Hold – Automatic

For automatic start and reset, choose **Automatic** mode.
 To enable this feature, enter the Peak Hold **Setup** menu.



Change the mode to **Automatic**.

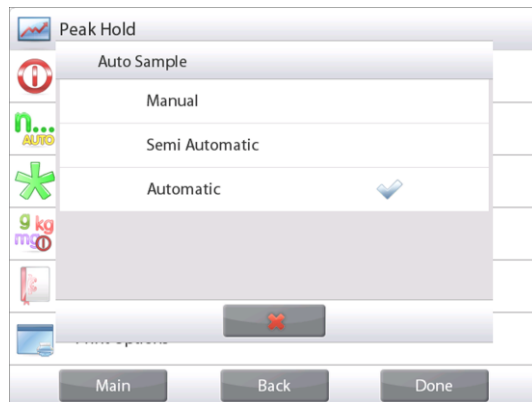

The **HIGH POINT – Auto** Home screen

- Main Display Line
- Second Display Line
- Reference Fields
- Application Buttons
- Functions



Application Icon

Place item on the pan. The capture process starts automatically.



The highest stable weight reading is held until the weight is removed.

The process starts automatically once the weight is removed from the pan (**after 10 second delay**).

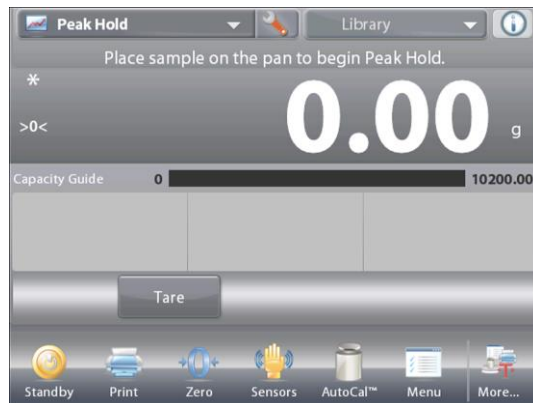

4.12 Ingredient Costing

This application allows the user to determine the cost of a formula or recipe based on the known cost and quantity of the components or ingredients. Up to 99 components are allowed.

In the upper left portion of the home screen, select **Ingredient Costing**. Follow the screen instructions to begin.



The **INGREDIENT COSTING** Home screen

Main Display Line
Second Display Line

Reference Fields

Application Buttons

Functions



Application Icon

4.12.1 Item Settings

Press **Item Settings** to set up items in memory.

The **Edit Settings** Screen.

Settings available: **Add New, Edit name, Edit Cost, Edit Unit, Delete Item, Clear All**

Functions Available: **Return to Application**

To set up the item(s) in memory, Press **Add New**.

A new item is added (default Name) with default info (cost per weight and weight unit).

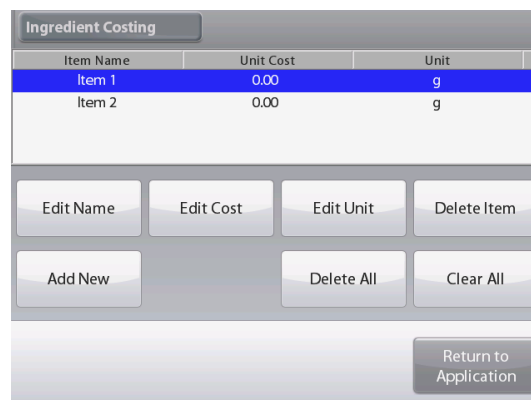
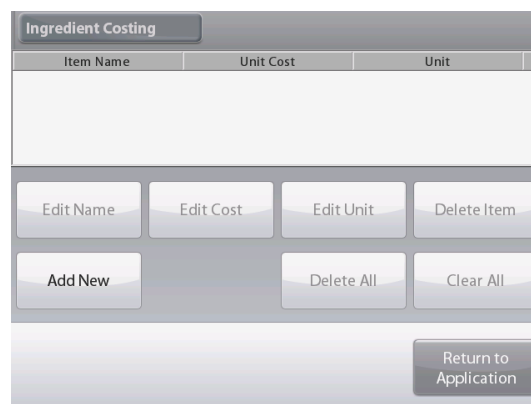

To change the default item name, Press **Edit Name**.
 The alpha-numeric entry screen appears.
 Enter the new name, then press ✓.
 The display returns to the previous screen with the new value highlighted momentarily.



To change the default component cost per unit, Press **Edit Cost**.
 The numeric entry screen appears.

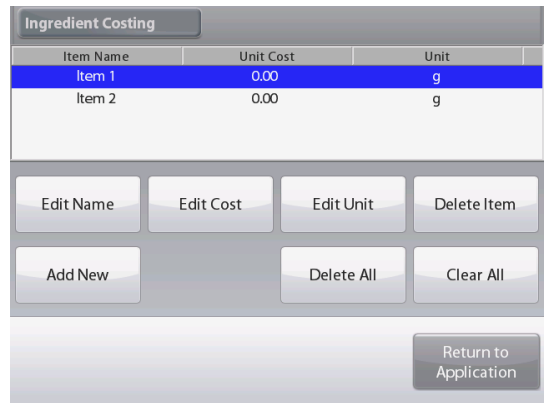

Enter the new weight, then press ✓.
 The display returns to the previous screen with the new value highlighted momentarily.



To change the default component Unit, press **Edit Unit**.
 The Weighing Units screen appears.



Continue adding items as required, using **Add New**.
New items can be added at any time.

To delete an item, touch the item to highlight it,
then press **Delete Item**.

To clear all items, press **Clear All**. A confirmation is required.
When finished, press **Return to Application**.

Once setup is complete and the application screen is displayed,
follow the screen instructions:

Add the first item then press **Accept** to store the value in
memory.

The weight of the item is recorded,
then the screen prompts for the next component.

Unit Cost, Total Weight and **Total Cost** are also displayed.

Continue follow the screen instructions to add the items to the
pan and touch the **Accept** button until each item has been
weighed.

Press the **View Data** button at any time to show the current
results: (**Item, Item Cost** and **Item Weight**).

After the last item has been weighed, press **View Data** to see
the results.

(Cancel the current data set by pressing **Clear Data**.)

Ingredient Costing Results.

Press **Print** to send the data to the enabled COM port.

Press **Close** to close the results window and return to the
Application home screen.

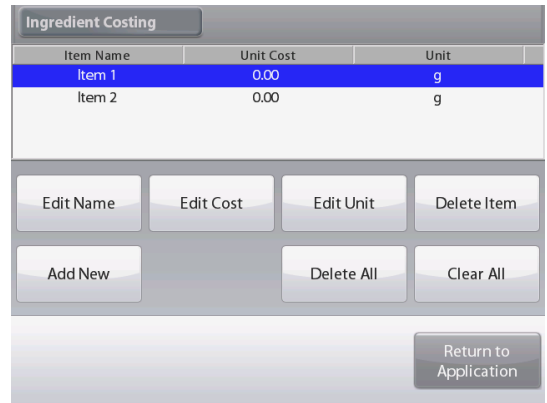

4.12.2 Application Setup

The Application can be customized for various user preferences.

Touch the **Setup** Icon (wrench) to enter Application Setup from the home screen.



The **Setup Menu** is now displayed.

Select the list item to view or change the setting as desired.

To return to the Application home screen, touch **Done**.

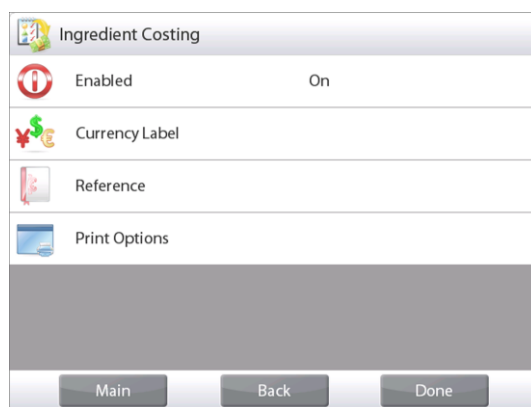

The Ingredient Costing Application Setups (defaults in **Bold)**

Item	Available Settings	Comments
Enabled	On , Off	Turns Application on/off
Currency label	None , various	To select the Currency label
Reference fields		
Unit Cost	On , Off	To display the Item cost
Total Weight	On , Off	To display the Total weight
Total Cost	On , Off	To display the Total cost
Gross	On, Off	Gross weight is displayed
Net	On, Off	Net weight is displayed
Tare	On, Off	Tare weight is displayed
Print Options		See Printing Section.
Total Weight	On , Off	
Total Cost	On , Off	

4.13 Pipette Adjustment (not available in EX12001, EX24001, EX35001)

Pipette adjustment checks the accuracy and precision values of pipettes by weight analysis. The balance has a built-in density reference table for water at temperatures between 10°C and 30°C. If other liquids are used for pipette calibration, enter the liquid's density at current room temperature in g/cm³. Since all calculations are made within the balance, the atmospheric pressure is also required.

Pipette adjustment can be accomplished **manually** (with a key press after each step) or **automatically** (weights are automatically recorded when stable). Calculations made within the balance provide results of inaccuracy and imprecision. Up to 30 samples can be used.



The **PIPETTE ADJUSTMENT** Home screen

- Main Display Line
- Second Display Line
- Reference Fields
- Application Buttons
- Functions



Application Icon

4.13.1 Pipette Adjustment – Manual (default)

Confirm the default values displayed are correct: Nominal, Inaccuracy, Imprecision, Density, Atmospheric Pressure, Water Temperature, etc.

To edit the default values, touch the **Edit Settings** button.

The **Edit Settings** Screen.

Settings available: **Nominal Capacity, Water Temp, Inaccuracy, Atmospheric Press, Imprecision, Pipette Name, Pipette Number**

Functions Available: **Return to Application**

To adjust the pipette Nominal Capacity value, touch the **Nominal** button.

Enter the Nominal Capacity in the keyboard screen that appears, and press ✓.

The display returns to the previous screen with the new value highlighted.

Note: Capacity can be measured in *mL* or *uL*, depending on the Application Setup.

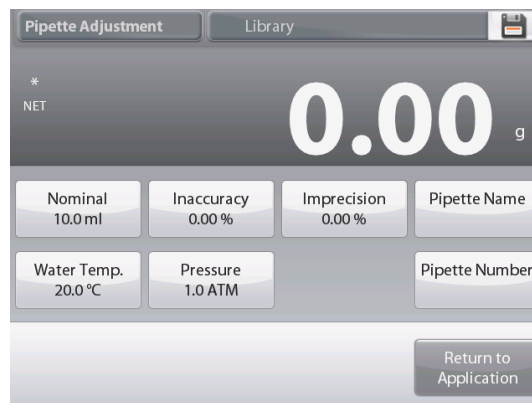

To adjust the water temperature, touch the **Water Temp** button.

The balance calculates water density based on the water temperature value entered. Measure the actual water temperature using a precision thermometer.

A numeric input window is displayed.

Key in the desired temperature, then press ✓.

The display returns to the previous screen with the new value highlighted.

Continue to enter the required information following the above procedure:

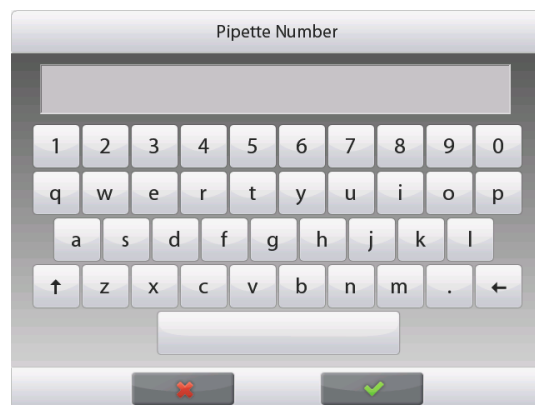
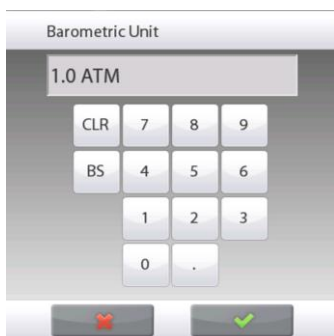
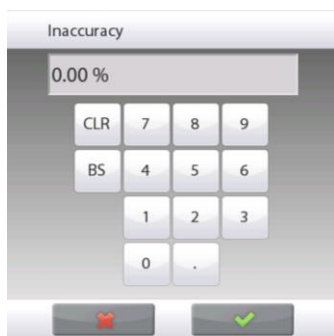

Pipette Inaccuracy, via the **Inaccuracy** button

Barometric Pressure, via the **Barometric Pressure** button

Pipette Imprecision, via the **Imprecision** button

Pipette Name, via the **Pipette Name** button

Pipette Number, via the **Pipette number** button

When finished, press **Return to Application**.

The Application home screen appears, and you can begin the Pipette Adjustment process.

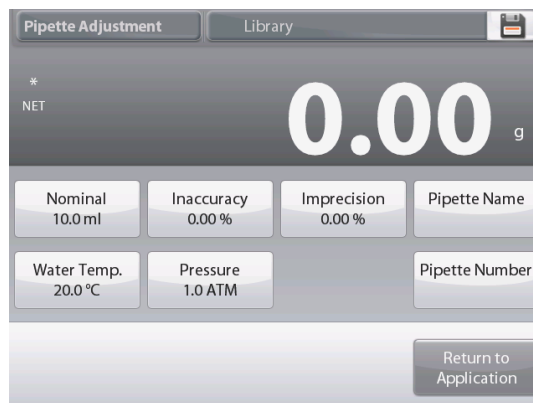

4.13.2 Begin Pipette Adjustment Process

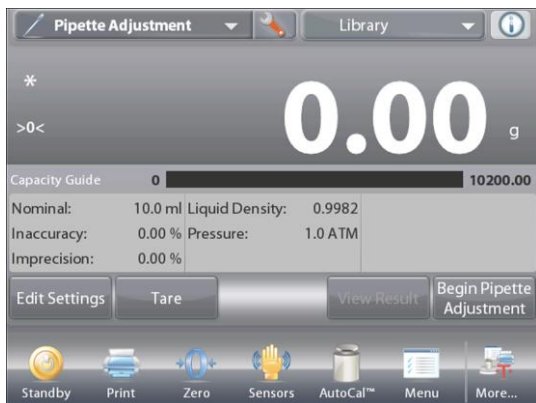

Touch **Begin Pipette Adjustment**. Follow the screen instructions, to **Place container on the pan**. Then **Press Tare**.

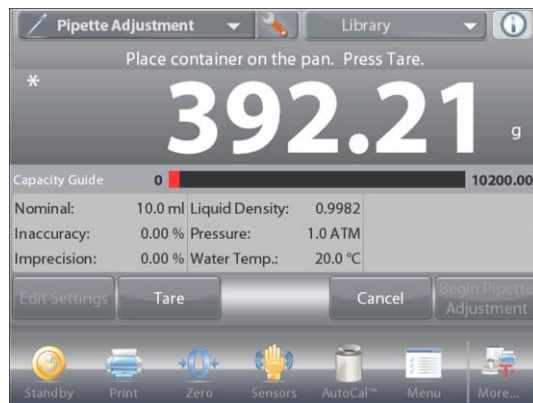

Step 1 – Dispense the First Sample

Follow the screen instructions, then press **Accept** to store the first sample weight (liquid).



Continue to follow the screen instructions by dispensing samples and pressing **Accept** to store each sample weight (liquid).

The default number of samples is 10.

It can be changed in Setup, from 2 to 30 samples.

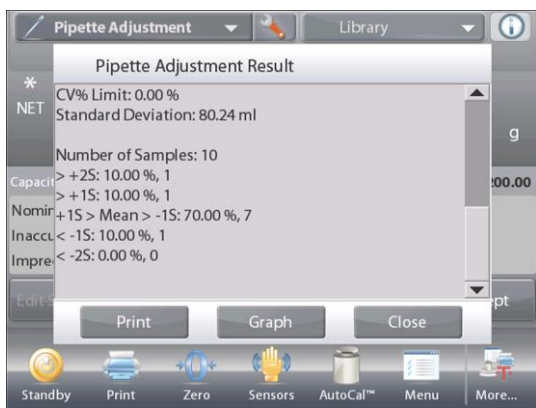

Once all the sample weights have been dispensed, the **Results** screen is automatically displayed.

Press **Graph** to see results plotted. Press **Result** to return to the result screen. Press **Close** to return to the Pipette Adjustment home screen.

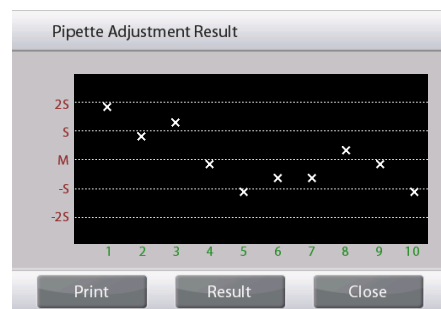

Note: To view either the results or graph screens again from the home screen, press the **View Result** button. To start a new Pipette Adjustment process, press **Begin Pipette Adjustment**.

4.13.3 Application Setup

The Application can be customized for various user preferences.

Touch the **Setup** Icon (wrench) to enter the **Application Setup** from the home screen.



The **Setup Menu** appears.

Select the list item to view or change the setting as desired.

To return to the Application home screen, touch **Done**.

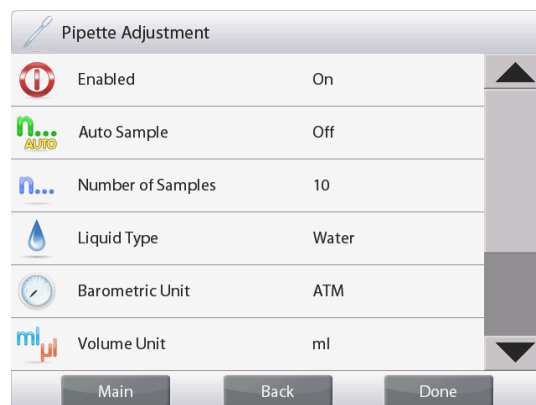

The Pipette Adjustment Application Setups (defaults in Bold)

Item	Available Settings	Comments
Enabled	On , Off	Turns Application on/off
Auto Sample Mode	On, Off o	To select the mode of operation
Number of Samples	2 – 30 (default 10)	To select the number of samples
Liquid Type	Water , Other	Liquid used during measurements
Unit of Pressure	ATM , inHg, KPa, mbar, mmHg, PSIA	To select Atmospheric Pressure unit
Volume Unit (Pipette capacity unit)	mL , uL	Nominal capacity unit
Secondary Unit	On, Off	To show the Second Display line
Lock Settings	On, Off	Press to lock the current setting(s) so they cannot be changed.
Reference fields		
Nominal Volume	On , Off	Nominal capacity displayed
Inaccuracy	On , Off	Inaccuracy value displayed
Imprecision	On , Off	Imprecision value displayed
Liquid Density	On , Off	Liquid density value displayed
Barometric Unit	On , Off	Barometric Pressure value displayed
Water Temperature	On , Off	Water temperature is displayed
Print Options		
Nominal Volume	On , Off	
Inaccuracy	On , Off	
Imprecision	On , Off	
Liquid Density	On , Off	
Barometric Unit	On , Off	
Water Temperature	On , Off	

4.14 Statistical Quality Control (SQC)

The Statistical Quality control (SQC) feature is useful during various types of process filling operations, to monitor and/or control the process to eliminate under- and over-filling.

As samples are weighed and stored in the balance, a Trend Analysis is developed and can be displayed. Up to 10 batches with up to 80 samples in a batch are visible for quality control purposes. Each batch of samples is shown, with the maximum, minimum, standard deviation and mean values for each batch. An on-going examination of the relative deviation of the samples along with other statistical data can be viewed.

The filling process operation can be effectively monitored by observing the results on the View Trace screen.

SQC collection can be done manually (**Manual** mode, requires key press after each step) or automatically (**Auto** Mode, the weights are automatically recorded when stable).

In the upper left portion of the home screen, select **SQC**.



The **SQC** Home screen

Main Display Line
Second Display Line

Reference Fields

Application Buttons

Functions



Application Icon

4.14.1 Edit Settings

Confirm the default values (**Nominal, Inaccuracy, Imprecision, Density, Atmospheric Pressure, Water Temperature, etc.**) are correct.

To view/edit the default values, touch the **Edit Settings** button. The Settings screen appears.

Settings available: **Nominal Target weight, +Tolerance 1, -Tolerance 1, +Tolerance 2, -Tolerance 2**

Functions Available: **Return to Application**

To adjust the Nominal Target weight value, touch the **Nominal** button.

A numeric input window appears.

Key in the desired Nominal Weight, then press ✓.

The display returns to the previous screen with the new value highlighted.



Continue to enter the required information following the above procedure:

Positive Tolerance 1, via the **+Tolerance 1** button.

Negative Tolerance 1, via the **-Tolerance 1** button.

Positive Tolerance 2, via the **+Tolerance 2** button.

Negative Tolerance 2, via the **-Tolerance 2** button.

Tolerances can be in either weight (default) or percent –

See **Application Setup**, Section 4.14.3.

When finished, press **Return to Application** and the SQC home screen appears.



4.14.2 Begin the SQC Process



Touch the **Begin New Batch** button.

First Batch: the screen prompts for the Batch name.

Enter the Batch name, then press ✓.



The Process screen is then displayed.

Follow the screen instructions, then press **Accept** to store the sample weight.

The current number of **Samples**, along with the **Average**, **Sum**, **Minimum** value, **Maximum** value, and **Range** are displayed.

Continue to follow the screen instructions by weighing samples and pressing **Accept** to store each sample's weight.

The sample size is 10 (default).

It can be changed in Setup from 2 to 80 pieces.

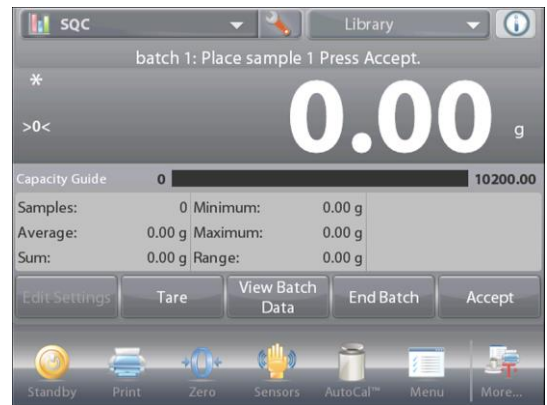

At any time, press **End Batch** to see the Individual results screen, showing results for the current Batch.

Once all the samples have been weighed, the **Results** screen appears *automatically*.

If the COM interface is enabled, press **Print** to send the results either to a computer or a printer.

Press **Close** to return to the current Batch process.

A message offers the chance to save the batch, if desired.

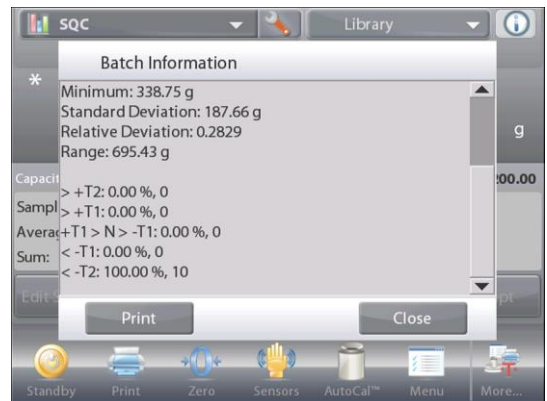

To view the process results of this batch (and any other saved batch), press the **View Batch History** button.



The Batch History screen shows the basic information – **Maximum, Minimum, Average** (mean), and **Standard Deviation** – for all currently saved batches.

Press **Select** to see (and print) the Batch Information screen for any saved batch.

Press **Clear Batches** to reset SQC results and return to the SQC home screen

Press **Close** to return to the SQC home screen to begin another batch or to view process results.



To view the Process results graphically (batch comparison), press the **View Trace** button.

Press **Print** or **Close** as above.

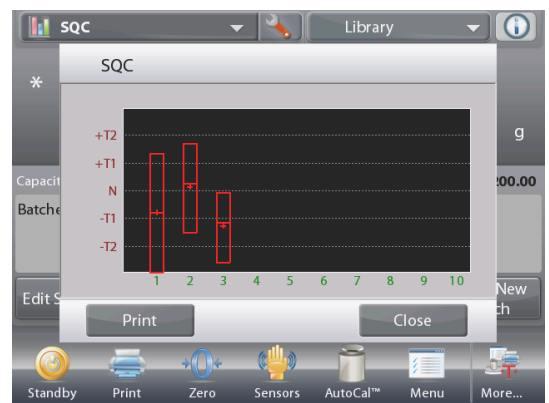

4.14.3 Application Setup

The Application can be customized for various user preferences.

Touch the **Setup** Icon (wrench) to enter **Application Setup** from the home screen.



The **Setup Menu** is now displayed.

Select the list item to view or change the setting as desired.

To return to the Application home screen, touch **Done**.

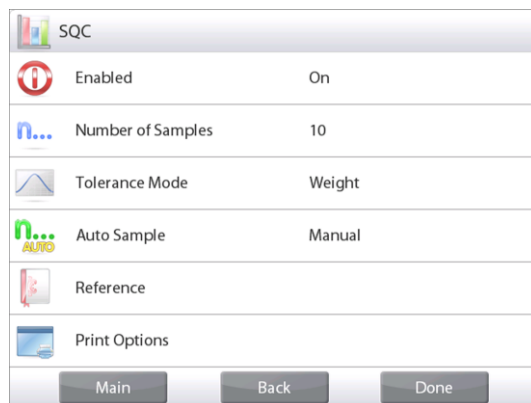

The SQC Application Setups (defaults in Bold)

Item	Available Settings	Comments
Enabled	On , Off	Turns Application on/off
Number of Samples	2 – 80 (default 10)	To select the number of samples in a Batch
Tolerance Mode	Weight , Percent	Tolerance used during measurements
Auto Sample Mode	Manual , Semi Automatic, Automatic	To select the mode of operation
Lock Settings	On, Off	Press to lock the current setting(s) so they cannot be changed.
Reference fields		
Number of Batches	On , Off	The total batches
Number of Samples	On , Off	The total samples
Average	On , Off	The Average value is displayed
Total	On , Off	The Sum value is displayed
Maximum	On , Off	The Maximum value is displayed
Minimum	On , Off	The Minimum value is displayed
Range	On , Off	The Range is displayed
Print Options		
See Printing Section.		
Number of Batches	On , Off	
Number of Samples	On , Off	
Average	On , Off	
Total	On , Off	
Maximum	On , Off	
Minimum	On , Off	
Range	On , Off	

4.15 Statistics

Statistics are used to compare a number of samples and examine the relative deviation of the samples along with other statistical data. A minimum of three samples is required.

Statistics can operate **manually** (key press after each step) or **automatically** (weights automatically recorded when stable). To use the statistics feature, enable it in the Application Setup menu.

This feature is available in Weighing, Counting, Check Weighing, Dynamic Weighing and Filling applications.

4.16 Library

When an item is processed on a regular basis, the item's data may be stored in memory for future use. This memory is referred to as the Balance's Library.

The following data is stored for the Application used:

Application	Parameters and setups	Name	Preset Tare	APW	Ref Wt. or Target	Sample size	Under Limit	Over Limit	Level	Mode
Weighing	x	x	x							
Counting	x	x	x	x		x	x	x		x
Percent Weighing	x	x	x		x					
Check Weighing	x	x	x				x	x		x
Dynamic Weighing		x	x						x	x
Filling	x	x	x		x					
Totalization	N/A	N/A	N/A	N/A	N/A	N/A	N/A	N/A	N/A	N/A
Formulation	N/A	N/A	N/A	N/A	N/A	N/A	N/A	N/A	N/A	N/A
Differential Weighing	N/A	N/A	N/A	N/A	N/A	N/A	N/A	N/A	N/A	N/A
Density Determination	x	x	x							
Peak Hold	N/A	N/A	N/A	N/A	N/A	N/A	N/A	N/A	N/A	N/A
Ingredient Costing	N/A	N/A	N/A	N/A	N/A	N/A	N/A	N/A	N/A	N/A
Pipette Adjustment	x	x	x							
SQC	x	x	x							

4.16.1 Creating a Library Record

To create a Library record, the Settings screen is used. From the home screen, touch the **Edit Settings** button. The Settings screen is now displayed.

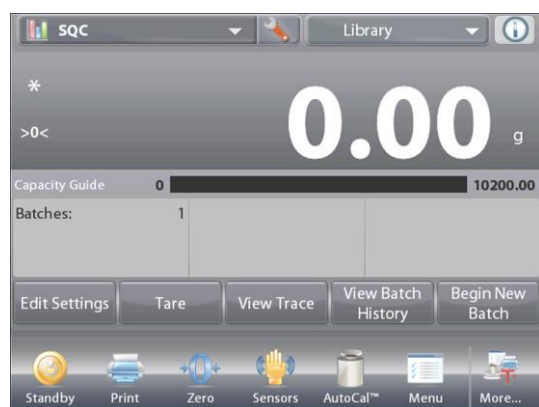

Touch the **Edit Settings** button.

The **Settings** screen appears.

Confirm the application settings; then touch **Save** (the diskette, *top-right*).

An alphanumeric entry screen appears, to enter the Library Record name.

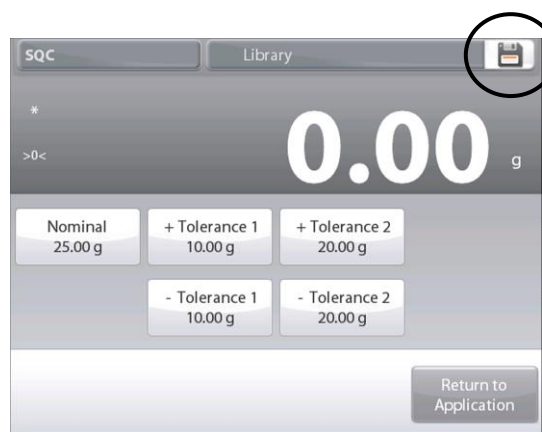



Enter the Record name, then press ✓.

Note: Library Record names can be 8 characters or less.

A **Record is saved** message appears. Press **OK**, then...

Press **Return to Application**.

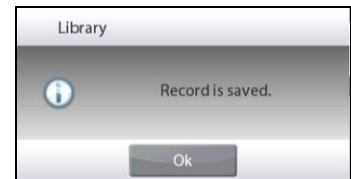

4.16.2 Retrieving a Library Record

Load a Library record from the home screen.

Press the **Library** bar in the upper right area of the screen. (It shows the name of the most recently used library file.)

The Library manager popup is now displayed.

Touch the Library Record to highlight it, then touch **Recall** to load the record's settings into the Application.

Then press **Close** to return to the home screen with the Library name displayed and the stored parameters active.

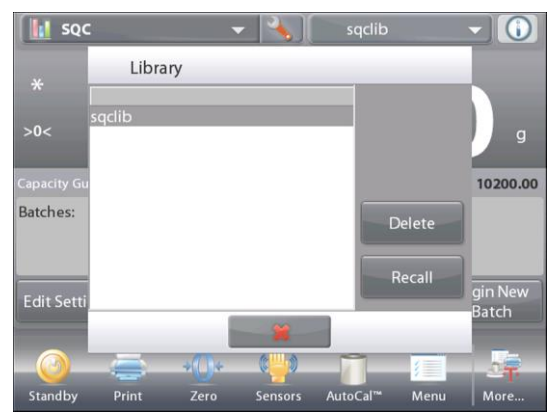

4.16.3 Deleting a Stored Library Record

To delete a stored record, follow "Retrieving a Library Record" above, but press **Delete** instead of **Recall**.

4.17 Additional Features

4.17.1 Weigh Below

The Explorer Balance is equipped with a weigh below hook for weighing below the balance.

Note: before turning the balance over, remove the Pan, Pan Support, Wind Ring/Shield and Draft Shield elements (if present) to prevent damage.



CAUTION: Do not place the balance on the pan support cone or Load cell Pins

To use this feature, remove power from the balance, then remove the protective cover for the weigh below opening (2 screws). The protective cover is reversible for easy storage.

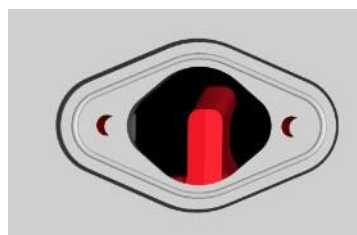

With Cover

Without Cover

The balance can be supported using lab jacks or any other convenient method. Ensure the balance is level and secure. Power on the Balance, then use a string or wire to attach items to be weighed.

5. MENU SETTINGS

5.1 Menu Navigation

All menu navigation is performed by touching the display. To enter the Menu, touch **Menu** from any Application Home screen. The Main menu appears, with buttons for **Main**, **Back** and **Done**. Continue touching the appropriate list item to navigate to the Menu items or touch a button to change location.

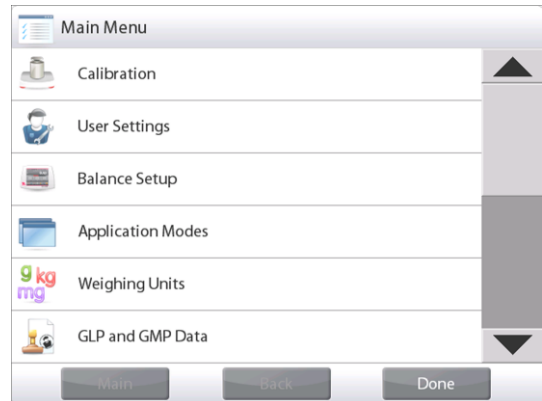

5.1.1 Changing Settings

To change a menu setting, navigate to that setting using the following steps:

Enter the Menu

From any Application screen, Touch **Menu**.
The Main Menu List appears on the display.

Select the Sub-Menu

Scroll down to the selected item of the Main Menu List and touch it. The Sub-Menu appears.

Select the Menu Item

Continue until the desired setting is chosen in the Menu list. Touch the setting to change it.
The changed setting will be displayed as highlighted for 2 seconds to confirm the changed value.

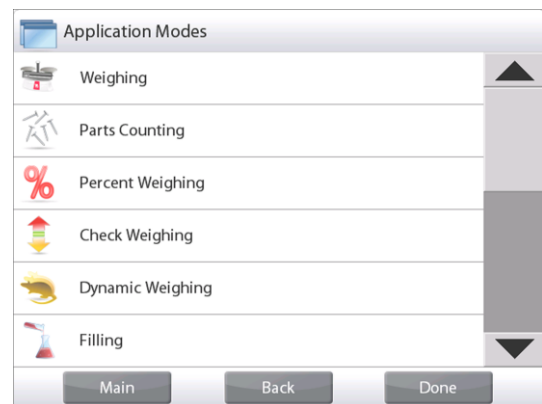

Exit the Menu and Return to the Current Application

After the setting is confirmed, touch **Done** to return to the Application.

Note: at any time the **Main**, **Back** & **Done** buttons can be touched to navigate to the desired area of the menu or return to the current Application.

5.2 Main Menu

The Explorer balance Main menu structure is illustrated below.



5.3 Calibration

Explorer Balances offer a choice of six calibration methods: Internal Calibration, Automatic Calibration (AutoCal), Calibration Adjust, Span Calibration, User Calibration and Calibration Test.

ExCal models have three calibration methods: Span Calibration, User Calibration and Calibration test.

Note: Do not disturb the balance during any calibration.

5.3.1 Calibration sub-menu



5.3.2 Internal Calibration (AutoCal™)

Calibration is accomplished with the internal calibration mass. Internal calibration can be performed at any time, provided the balance has warmed up to operating temperature and is level.

With the Balance turned ON and no load on the pan, touch **AutoCal™ Internal Calibration**. The Balance begins to calibrate.

Alternately, touch the shortcut **Calibration** Icon from any Application home screen to initiate an Internal Calibration.



The display shows the status, then returns to the current application.

To cancel at any time, press **Cancel**.

5.3.3 Automatic Calibration

When **Automatic Calibration** is set ON, the balance performs a self calibration:

- when it senses a temperature change of 1.5°C
- or every 11 hours

AutoCal will automatically calibrate the Balance (using the internal mass) each time there is a change in temperature significant enough to affect accuracy.

5.3.4 AutoCal™ Adjustment

Use this calibration method to adjust the zero calibration point, without affecting the span or linearity calibration.

Calibration Adjust may be used to adjust the result of the Internal calibration by ± 100 divisions.

Note: Before making a calibration adjustment, perform an Internal Calibration. To verify whether an adjustment is needed, place a test mass equal to the **span calibration value*** on the pan and note the difference (in divisions) between the nominal mass value and the actual Balance reading. If the difference is within ± 1 division, calibration adjustment is not required. If the difference exceeds ± 1 division, calibration adjustment is recommended. (*See Table 5-1, below.)

Example:

Actual weight reading:	200.014
Expected weight reading:	200.000 (Test mass value)
Difference Weight (d):	0.014
Difference weight in digits:	-14 (Adjust value)

To perform a Calibration Adjustment, touch AutoCal Adjustment from the Calibration Menu; Enter the value (positive or negative divisions) to match the difference noted earlier in the procedure and press ✓.

Recalibrate using Internal Calibration. After calibration, place the test mass on the pan and verify that the mass value now matches the displayed value. If not, repeat the procedure until Internal Calibration reading agrees with the test mass.

Once completed, the balance stores the Adjustment value and the display returns to the current application.

5.3.5 Span Calibration

Span calibration uses two calibration points, one at zero load and the other at specified full load (span). Refer to Table 5.1 for Span values. For detailed calibration mass information please see the specification tables in section 9.

Note: Factory default settings are shown in bold.

TABLE 5-1 Calibration Masses

Model	Span Calibration Points	Weight Class	
EX124	50g, 100g	ASTM Class 1	OIML E2
EX224	100g, 150g, 200g	ASTM Class 1	OIML E2
EX324, M, N	150g, 200g, 300g	ASTM Class 1	OIML E2
EX223	100g, 150g, 200g	ASTM Class 1	OIML E2
EX423	200g, 300g, 400g	ASTM Class 1	OIML E2
EX623	300g, 400g, 500g , 600g	ASTM Class 1	OIML E2
EX1103, M, N	500g, 1000g	ASTM Class 1	OIML E2
EX2202	1000g, 2000g	ASTM Class 1	OIML E2
EX4202	2000g, 3000g, 4000g	ASTM Class 1	OIML E2
EX6202	3000g, 4000g, 5000g , 6000g	ASTM Class 1	OIML E2
EX10202, M, N	5000g, 10,000g	ASTM Class 1	OIML E2
EX6201	3000g, 4000g, 5000g , 6000g	ASTM Class 2	OIML F1
EX10201	5000g, 10,000g	ASTM Class 1	OIML E2
EX12001	3000g, 5000g, 10000g, 12000g	ASTM Class 2	OIML F1
EX24001	10000g, 15000g, 20000g, 24000g	ASTM Class 1	OIML F1
EX35001	10000g, 20000g, 30000g, 35000g	ASTM Class 1	OIML F1

With the balance turned ON and no load on the pan, touch Span Calibration to initiate the procedure. Additional calibration values to be used are shown on the display. The best accuracy is achieved using the mass closest to the full span value.

Note: To change the span calibration point, touch the alternate weight shown on the display. Follow the screen instructions and place the specified calibration weight on the scale when prompted to do so. When complete, the display shows the Span calibration status and returns to the current application.

5.3.6 User Calibration

User Calibration is used to calibrate the balance using a user defined mass.

With no load on the scale, press **User Calibration** from the calibration sub-menu.

The display shows the current full load (span) calibration point and calibration unit of measure.

To change the value to a user-defined weight, touch **ENTER VALUE**.

Enter the weight via the popup screen. The balance then prompts for the User-defined weight.

Place the specified calibration weight on the balance and the calibration process completes.

The display shows status, then returns to the current application.

5.3.7 Calibration Test

Use Calibration Test to compare a known calibration weight against the stored span calibration data.

With no load on the scale, press **Cal Test** to begin the process.

The balance captures the zero point, then prompts for the span value.

The display shows status, followed by the difference between the current calibration weight and the stored calibration data.

After 3 seconds, the display returns to the current application.

5.4 User Settings

When using the Balance for the first time, enter this sub-menu to set User-defined values like **Language**, **Display Settings**, **Volume**, **Functions Configuration** and the **Touchless Sensor** setup.

5.4.1 User Settings Sub-menu



Language



Volume



Display Settings



User Manager



Functions Configuration



Sensor Setup

Draft Shield Light
(Analytical models)

Factory default settings are shown below in bold.

5.4.2 Language

Set the language displayed for menus and displayed messages.

English
German
French
Spanish
Italian
Chinese
Korean
Japanese
Russian
Polish
Portuguese
Czech
Hungarian



5.4.3 Volume

Controls the built-in Speaker loudness.

Default value= **5** (mid-level)

0= disabled (Off)

Range is 0 to 10

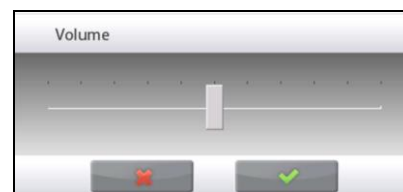

5.4.4 Display Settings

Use this sub-menu to change the setting for:

Screen Brightness: Default value= **100**

Range is 20 to 100

Touch Calibrate

“Touch the screen at the center of the ring. **O** Press here.”

(First top-left, then bottom-right.)

Auto Dim (Dims the display if no Screen Activity for x minutes)

Default value = **OFF** (disabled). Range is 1 to 240 minutes

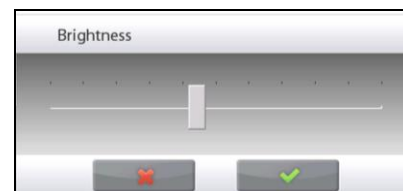

5.4.5 User Manager

Enter this sub-menu to create user profiles if desired.

Touch New to create a new user profile.

The *Enter User Name* screen appears. Enter the desired user name with the keys displayed.

Note:

The first user will automatically be set as Administrator.

To add additional standard users, put the balance in standby mode (by pressing Standby button in application home screen) and then login with the newly created Administrator credentials. In User Profiles the button **New** will be available.

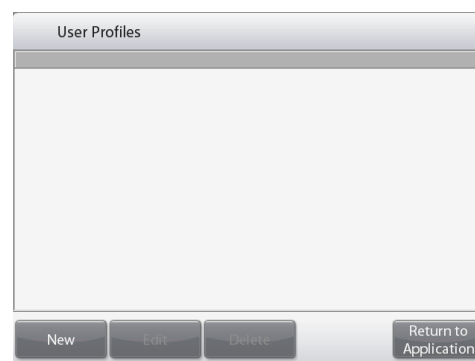

User Level: Default is Standard User (max 5); Administrator (max 1) is available.

Change PIN: Choose a password for the user if desired.

Lockout: Can be used by Administrator to lockout the Menu items of a named User.

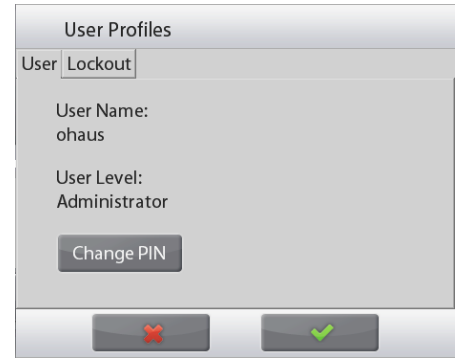

After a user profile has been created, the following buttons are available:

New: Add a new user profile

Edit: Edit an existing user profile

Delete: Delete an existing user profile

Note: The **New** button will only be available when logged in as Administrator.

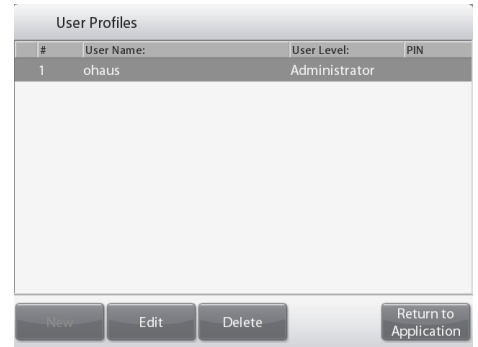

5.4.6 Functions Configuration

Touch **Functions Configuration** to see a table of Selected and Available functions. Press > to move a function from **Available** to **Selected**, and press < to move them back. To move all functions to the right, Press >> and press << to move them back.



5.4.7 TouchLess Sensor Setup

If desired, assign **Print, Zero, Tare, Calibrate, Automatic draftshield door** or **Draft Shield Light** to the Touchless Sensors **Terminal Right, Terminal Left, Base Right, and Base Left**.

Default setting for Automatic draftshield door models:

Terminal left: left door

Terminal right: right door



Note: EX12001, EX24001 and EX35001 do not have Base sensors.

5.4.8 Draft Shield light

Set the status of the lighted Draft Shield feature.

OFF = disabled.

ON = enabled.

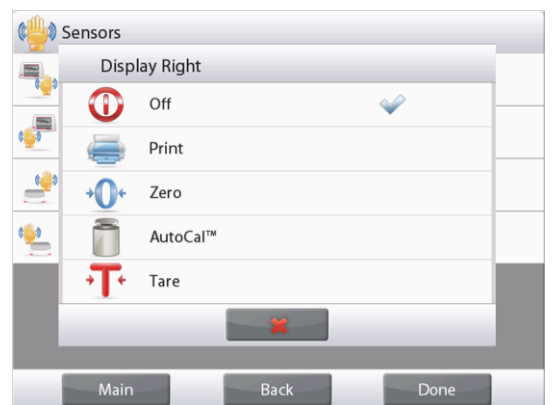

5.5 Balance Setup

Enter this sub-menu to customize Balance display functionality.

5.5.1 Balance Set-up sub-menu



Factory default settings are shown below in bold.



5.5.2 Stable Range

Set the amount the reading can vary while the stability symbol remains on.

0.5 D	= 0.5 graduations
1 D	= 1 graduation
2 D	= 2 graduations
3 D	= 3 graduations
5 D	= 5 graduations

Note: When LEGAL FOR TRADE (below) is set to ON, the setting is forced to 1 D. The setting is locked when the Security Switch is set to the ON position.



5.5.3 Filter level

Set the amount of signal filtering.

LOW	= faster stabilization time with less stability.
MEDIUM	= normal stabilization time with normal stability.
HIGH	= slower stabilization time with more stability.



5.5.4 Auto Zero Tracking

Set the automatic zero tracking functionality.

OFF	= disabled.
0.5 D	= display maintains zero up to a drift of 0.5 graduation per second
1 D	= display maintains zero up to a drift of 1 graduation per second.
3 D	= display maintains zero up to a drift of 3 graduations per second.

Note: When Legal for Trade is set to ON, the AZT setting is forced to 0.5 D. The OFF setting is still available. The setting is locked at the current setting when the security switch is set to the ON position



5.5.5 Auto Tare
Set the automatic Tare.

OFF = disabled.
ON = enabled.



5.5.6 Gross Indicator
Set the symbol displayed for gross weights.

OFF = no symbol is displayed.
GROSS = the G symbol is displayed.
BRUTTO = the B symbol is displayed.



5.5.7 Legal For Trade
Use this menu to set the Legal for Trade status.

OFF = standard operation.
ON = operation complies with Weights and Measures regulations.

Note: When Legal for Trade is set to ON, the menu settings are affected as follows:

Calibration Menu:

AutoCal internal Calibration is forced to ON and hidden. Automatic Calibration, and Calibration Test functions are available. All other functions are hidden.

Balance Setup Menu:

Stability Indicator Range is locked at 1 Division.

Auto Zero Tracking is limited to 0.5 Division and OFF.

Auto Tare and Gross Indicator are locked at their current setting.

Graduations is forced to 1 Division and the menu item is hidden.

Weighing Units menu: all units are locked at their current settings.

Communication Menu:

Stable Weight Only is locked ON.

Numeric Value Only is locked OFF.

Auto print mode selections are limited to OFF, On Stability, and Interval.

Continuous is not available.

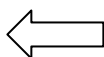

Note: The security switch must be in the locked position to set Legal for Trade to ON. The security switch must be in the unlocked position to set Legal for Trade to OFF. See Section 6.



5.5.8 Graduations
Set the displayed readability of the balance.

1 Division = standard readability.
10 Divisions = readability is increased by a factor of 10.

For example, if the standard readability is 0.01g, selecting 10 Divisions will result in a displayed reading of 0.1g.



5.5.9 Date & Time
Set the current Date and Time.

Change the format (if desired), then enter the current value.

Select ✓ to return to the sub-menu.

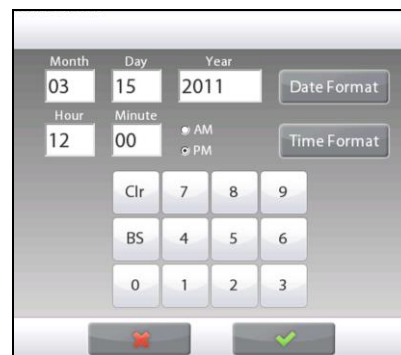

5.6 Applications

Enter this sub-menu to activate the desired Balance Applications. Only one application can be running at a time.

(The use of each Application is described in detail in Section 4.)

5.6.1 Turning an Application ON/OFF

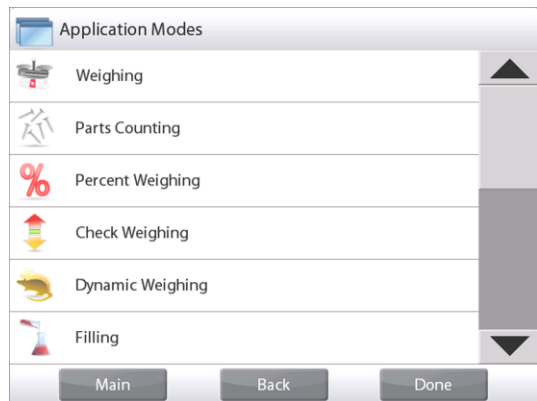

Touch line of the desired application. In the Item option screen, touch the **Enabled** line to toggle it on or off. Once an Application is enabled (turned on) it may be chosen from the **Applications** shortcut (top-left of all home screens).

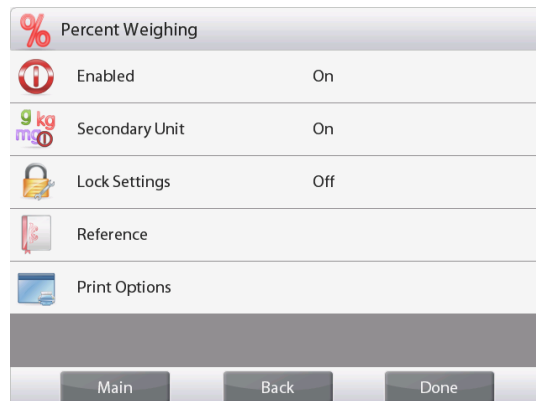

The current menu item status is shown: OFF = disabled, **ON** = enabled

5.7 Weighing Units

Enter this sub-menu to activate the desired units of measure.

Note: Due to national laws, the indicator may not include some of the units of measure listed.

5.7.1 Units Sub-menu

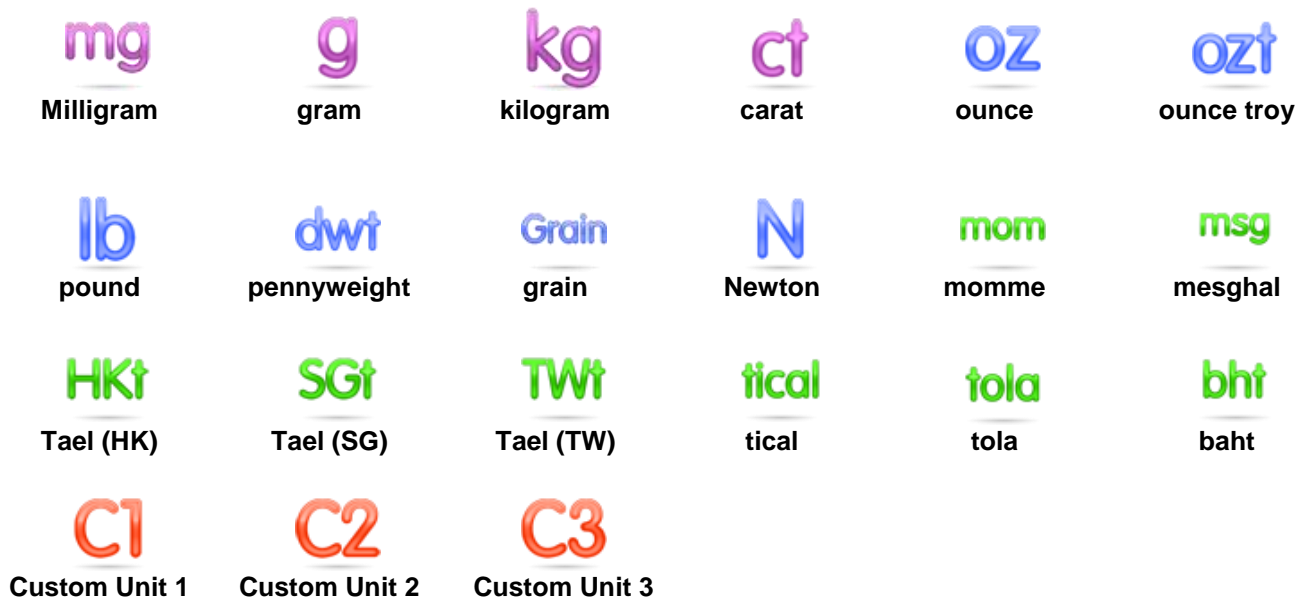

Notes: If **LEGAL FOR TRADE** is set to **ON**, the Unit menu is locked. The Custom Units names can be customized up to 3 characters.

5.7.2 Turning a Unit ON/OFF

Select the desired unit, then touch the item to toggle it either on or off.

The current menu item status is shown.

OFF = disabled
ON = enabled



5.7.3 Custom Units

Use each Custom Unit to display weight in an alternative unit of measure. The custom unit is defined using a conversion factor, where the conversion factor is the number of custom units per kilogram expressed in scientific notation (Factor x 10^{Exponent}).

For example: To display weight in troy ounces (32.15075 troy ounces per kilogram) enter a Factor of 0.321508 and an Exponent of 2.

Set the status.

OFF = disabled
ON = enabled

When Custom Unit is set to ON, the Factor, Exponent and Least Significant Digit must be set.

Factor

Set the conversion factor using the numeric keypad.

Settings of 0.00001 to 1.9999999 are available. The default setting is **1.000000**

Exponent

Set the factor multiplier.

0 = multiply the Factor by 1 (1x10⁰)
 1 = multiply the Factor by 10 (1x10¹)
 2 = multiply the Factor by 100 (1x10²)
 3 = multiply the Factor by 1000 (1x10³)
 -3 = divide the Factor by 1000 (1x10⁻³)
 -2 = divide the Factor by 100 (1x10⁻²)
 -1 = divide the Factor by 10 (1x10⁻¹)

Least Significant Digit

Set the graduation.

Settings of 0.00001, 0.00002, 0.00005, 0.0001, 0.0002, 0.0005, **0.001**, 0.002, 0.005, 0.01, 0.02, 0.05, 0.1, 0.2, 0.5, 1, 2, 5, 10, 20, 50, 100, 200, 500 and 1000 are available.

Note: Least Significant Digit setting selections are dependent on the Factor and Exponent settings. Selections are limited.

5.8 GLP and GMP Data

Enter this menu to set the Good laboratory Practices (GLP) data.

5.8.1 GLP Data Sub-menu



5.8.2 Header

Enables the printing of GLP headings. There are up to 5 headings available.

Alphanumeric settings up to 25 characters are available for each Header setting. .



5.8.3 Balance Name

Set the balance identification.

Alphanumeric settings up to 25 characters are available. The default setting is **blank**.



5.8.4 User Name

Set the user identification.

Alphanumeric settings up to 25 characters are available. The default setting is **blank**.



5.8.5 Project Name

Enter this menu to set the Project identification.

Alphanumeric settings up to 25 characters are available. The default setting is **blank**.

5.9 Communication

Enter this menu to define external communication methods and to set printing parameters.

Data may be output to either a printer or PC (See Section 5.9.8 for output samples.)

Factory default settings are shown in bold.

Notes: The COM3 menu is only available if the optional Interface is installed.

5.9.1 Communication Sub-menu



There are two types of USB interfaces on the Explorer:

Type A

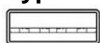

Use this interface to transfer weighing data directly to a USB flash drive. See 'Printing to USB flash drive Instruction Manual' for detailed instructions.

Mini-B



Use this interface to connect the balance to a computer or printer.

Choosing an item brings up another menu level (*RS232 shown*):



Choosing a Settings item brings up yet another menu level; the device settings are dependent on the COM chosen (*RS232 shown*)

Device Settings Menu: (*RS232 shown*)



5.9.2 Baud Rate

Set the baud rate (bits per second).

2400	= 2400 bps
4800	= 4800 bps
9600	= 9600 bps
19200	= 19200 bps
38400	= 38400 bps



5.9.3 Transmission

Set the data bits, stop bit, and parity.

7 EVEN 1	= 7 data bits, even parity
7 ODD 1	= 7 data bits, odd parity
7 NONE 1	= 7 data bits, no parity
8 NONE 1	= 8 data bits, no parity
7 EVEN 2	= 7 data bits, even parity
7 ODD 2	= 7 data bits, odd parity
7 NONE 2	= 7 data bits, no parity
8 NONE 2	= 8 data bits, no parity



5.9.4 Handshake

Set the flow control method.

NONE	= no handshaking
XON-XOFF	= XON/XOFF handshaking
HARDWARE	= hardware handshaking (COM1 menu only)



5.9.5 Alternate Command

Enter this sub-menu to set a different command character for the P (Print), T (Tare) or Z (Zero) commands.

Note: The selected character can only be used for one command.

Alternate Print Command

Set the alternate command character for Print.

Settings of A to Z are available. The default setting is **P**, except T&Z.

Alternate Tare Command

Set the alternate command character for Tare.

Settings of A to Z are available. The default setting is **T**, except P&Z.

Alternate Zero Command

Set the alternate command character for Zero.

Settings of A to Z are available. The default setting is **Z**, except P&T.

Print Settings Menu:

Note: If LEGAL FOR TRADE is set to ON, the print Output-Stable setting is not reset.



5.9.6 Print Output

Print Stable Weight Only

Set the printing criteria.

OFF	= values are printed immediately, regardless of stability.
ON	= values are printed only when the stability criteria are met.

Print Numeric Value Only

Set the printing criteria.

OFF	= All data values are printed
ON	= Only numeric data values are printed



5.9.7 Auto Print

Set the automatic printing functionality.

- OFF** = disabled
- ON STABLE** = printing occurs each time the stability criteria are met.
- INTERVAL** = printing occurs at the defined time interval.
- CONTINUOUS** = printing occurs continuously.

When ON STABLE is selected, set the conditions for printing.

- LOAD** = Prints when the displayed load is stable.
- LOAD ZERO** = Prints when the displayed load or zero reading is stable.

When INTERVAL is selected, set the time interval using the numeric keypad.

Settings of 1 to 3600 seconds are available.



5.9.8 Print Calibration Data

Set the automatic Calibration Data printing functionality.

- OFF** = disabled
- ON** = enabled



5.9.9 Print Content

Enter this sub-menu to define the content of the printed data.

See details below:

Header

Set the status.

- OFF** = the user defined header is not printed.
- ON** = the user defined header is printed.

```

USER DEFINED TEXT
USER DEFINED TEXT
USER DEFINED TEXT
USER DEFINED TEXT
USER DEFINED TEXT
  
```

Note: The header information must be defined using the H x "text" interface command. (See Section 5.1.)

Date and Time

Set the status.

- OFF** = the time and date are not printed.
- ON** = the time and date are printed.

```

01/31/10  12:30 PM
  
```

Balance ID

Set the status.

- OFF** = the Balance ID value is not printed.
- ON** = the Balance ID value is printed.

```

Balance Id: XXXXXXXX
  
```

Balance Name

Set the status.

- OFF** = the Balance Name is not printed.
- ON** = the Balance Name is printed.

```

Balance Name: XXXXXXXX
  
```

User Name

Set the status.

- OFF** = the User Name is not printed.
- ON** = the User Name is printed.

```

User Name: XXXXXXXXXXXX
  
```

Project Name

Set the status.

- OFF** = the Project Name is not printed.
- ON** = the Project Name is printed.

```

Project Name: XXXXXXXXXXXX
  
```

Application Name

Set the status.

- OFF** = the Application Name is not printed.
- ON** = the Application Name is printed.

```

Application Name: XXXXXXXXXXXX
  
```

Result

Set the status.

- OFF** = the displayed reading is not printed.
- ON** = the displayed reading is printed.

NUMERIC ONLY = only the numeric portion of the displayed reading is printed.

Gross

Set the status.

- OFF** = the gross weight is not printed.
- ON** = the gross weight is printed.

```

12.000 kg
  
```

Net

Set the status.

- OFF** = the net weight is not printed.
- ON** = the net weight is printed.

```

10.000 kg NET
  
```

Tare

Set the status.

- OFF** = the tare weight is not printed.
- ON** = the tare weight is printed.

Information

Set the status.

- OFF** = the reference info is not printed.
- ON** = the reference info is printed.

Note: See below for more clarification

Signature Line

Set the status.

- OFF** = the Signature Line is not printed.
- ON** = the Signature Line is printed.

```

Signature: _____
Verified by: _____
  
```

Note: "Verified by" is to be signed by an officer from local metrological regulation office to assert that the weighing and/or calibration results are in accordance with regulations.

Note: The Information is dependent on the application and the ACCUMULATE setting. Examples are shown below.

Mode	Accumulate set OFF	Accumulate set ON
Weighing	None	N: 10 Total: 10.000 kg Avg: 1.000 kg Std: 0.001 kg Min: 0.999 kg Max: 1.001 kg Diff: 0.002 kg
Counting	APW: 0.100 kg	N: 10 Total: 1000 Pcs Avg: 100 Pcs Std: 1 Pcs Min: 99 Pcs Max: 101 Pcs Diff: 2 Pcs
Check Weighing	Under: 0.995 kg Over: 1.005 kg	Under: 0.995 kg Over: 1.005 kg N: 10 Total: 10.000 kg Avg: 1.000 kg Std: 0.001 kg Min: 0.999 kg Max: 1.001 kg Diff: 0.002 kg
Dynamic	Level: 0	Level: 0 N: 10 Total: 10.000 kg Avg: 1.000 kg Std: 0.001 kg Min: 0.999 kg Max: 1.001 kg Diff: 0.002 kg



5.9.10 Print Layout

This sub-menu is used to define the format of the data output to a printer or computer.

Format

Set the printing format.

- MULTI** = a multiple line printout is generated. A CRLF is added after each data output.
- SINGLE** = a single line printout is generated. A TAB delimiter is added between each data output.

Feed

Set the paper feed.

- NONE** = the paper remains in its current position after printing.
- LINE** = move the paper up one line after printing.
- 4 LINE** = move the paper up four lines after printing.
- FORM** = a form feed is appended to the output.



5.9.11 Data Transfer Function

Output weighing results directly to a PC application. Setup is easy and no additional software is required.

Note: Data Transfer Function is not supported in Win7. OHAUS provides SPDC software for Win7 users.

- OFF** = do not print.
- ON** = print the specified settings.

Click the Start Menu in Windows XP system and click “Settings” →open **Control Panel**.

Double click **Accessibility Options** in Control Panel.

Select the **General** tab in Accessibility Options.

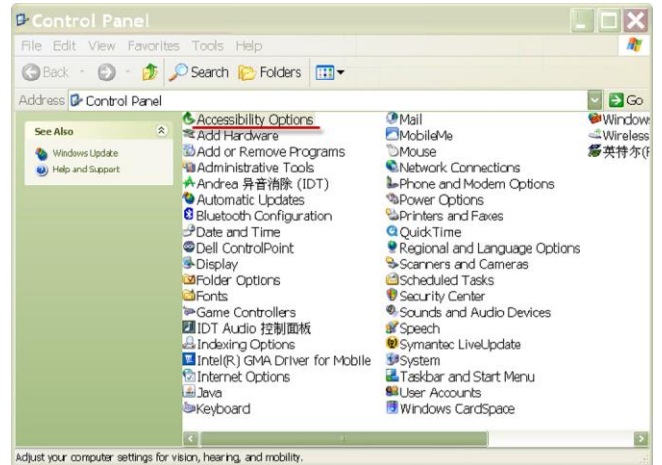

Check **Use Serial Keys**, and click the **Settings** button.

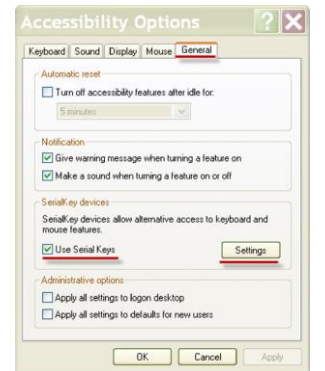

++
Select the **Serial Port**, and set the **Baud rate** to **9600**.

After selecting, click **OK** to close setting for serial keys.

Close the Control Panel.

Run Excel to open one blank sheet. Focus the cursor on one item.
At this time, if scale sends data to the PC through the RS232 port, the data will be put into the cell, and the cursor will automatically move to the next vertical cell.

Note: If the weighing value is a negative number, set the target cell in TEXT format. Otherwise, Excel will not distinguish it as a negative number.

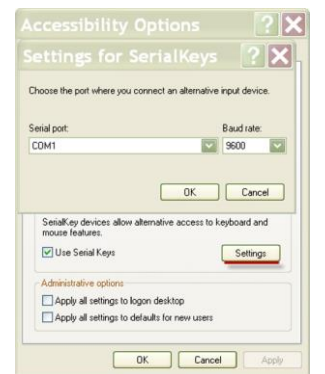

5.10 Library

When an item is processed on a regular basis, the item's data may be stored in memory for future use. This memory is referred to as the Balance's Library.

Refer to Section 4 for details.

5.11 I/O Settings

Enter this menu to set the optional input and output device parameters.

Set the function to be controlled by an optional external input device, such as a footswitch. There are four possible settings for each.

OFF	= disabled
ZERO	= equivalent to pressing the ZERO button.
TARE	= equivalent to pressing the TARE button.
PRINT	= equivalent to pressing the PRINT button.

5.12 Diagnostics

Use this menu to enable the Diagnostics (troubleshooting) functions, and to enter the Service menu;



5.12.1 Level Bubble Light (not available in EX12001, EX24001, EX35001)

To verify proper operation of the illuminated Level Bubble.

When selected, this light should blink.



5.12.2 Draft Shield Light (Analytical models)

To verify proper operation of the Draft Shield Light.

When selected, this light should blink.



5.12.3 Sensors

To verify proper operation of each Touchless Sensor.

When operated, each sensor should light and make a sound.



5.12.4 Automatic draftshield door

To verify proper operation of each Touchless Sensor.

When operated, each sensor should light and make a sound.

Note: Only for Automatic draftshield door models



5.12.5 Service Menu

Used to enter the Ohaus Service menu (Service personnel only). A password is required to access this menu;

5.13 Factory Reset

Use this sub-menu to reset the menus to their Factory default settings.

5.13.1 Factory Reset Sub-menu

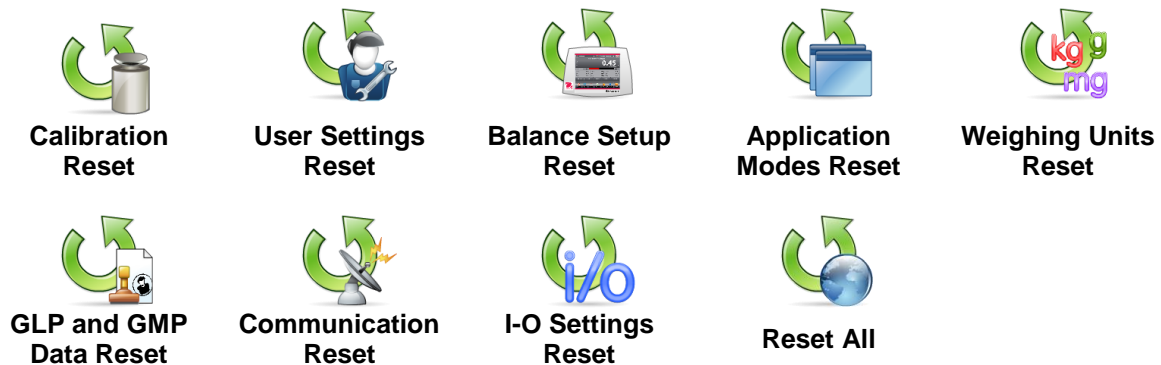

5.13.2 Reset Calibration

Select **YES** to return all Calibration menu items to their factory settings.

5.13.3 Reset User Settings

Select **YES** to return all User Settings menu items to their factory settings.

5.13.4 Reset Balance Setup

Select **YES** to return all Balance Setup menu items to their factory settings.

5.13.5 Reset Application Modes

Select **YES** to return all Application Modes menu items to their factory settings.

5.13.6 Reset Weighing Units

Select **YES** to return all Weighing Units menu items to their factory settings.

5.13.7 Reset GLP and GMP Data

Select **YES** to return all GLP and GMP Data menu items to their factory settings.

5.13.8 Reset Communication

Select **YES** to return all Communication menu items to their factory settings.

5.13.9 Reset I/O Settings

Select **YES** to return all I/O Settings menu items to their factory settings.

5.13.10 Reset All (Global Reset)

Select **YES** to return all the menu items to their factory settings.

5.14 Lockout

Use this menu to prevent unauthorized changes to menu settings. When the menu is locked and the security switch is set to ON, the locked menus can be viewed but not changed. Factory default settings are shown in bold.

5.14.1 Lockout Sub-menu

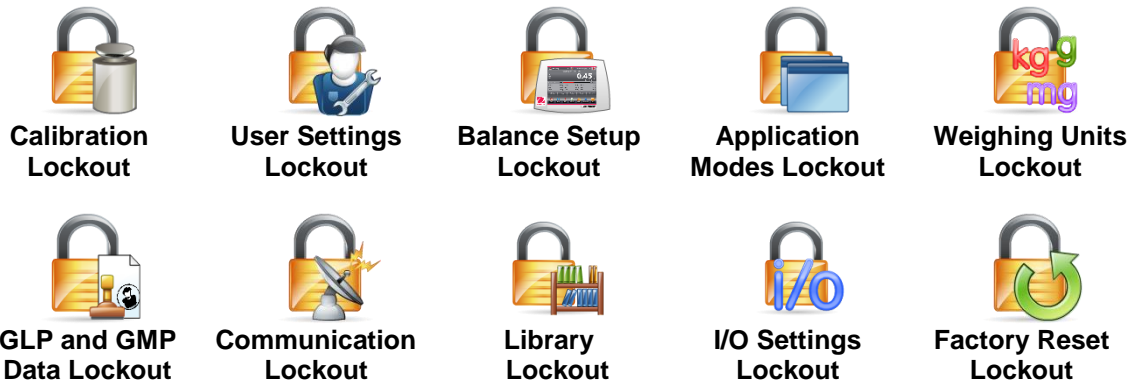

5.14.2 Lock Calibration

Set the status.

UNLOCKED = the Calibration menu is not locked.
LOCKED = the Calibration menu is locked.

5.14.3 Lock User Settings

Set the status.

UNLOCKED = the User Settings menu is not locked.
LOCKED = the User Settings menu is locked.

5.14.4 Lock Balance Setup

Set the status.

UNLOCKED = the Balance Setup menu is not locked.
LOCKED = the Balance Setup menu is locked.

5.14.5 Lock Application Modes

Set the status.

UNLOCKED = the Applications menu is not locked.
LOCKED = the Applications menu is locked.

5.14.6 Lock Weighing Units

Set the status.

UNLOCKED = the Units menu is not locked.
LOCKED = the Units menu is locked.

5.14.7 Lock GLP and GMP Data

Set the status.

UNLOCKED = the GLP and GMP Data menu is not locked.
LOCKED = the GLP and GMP Data menu is locked.

5.14.8 Lock Communication

Set the status.

UNLOCKED = the Communication menu is not locked.
LOCKED = the Communication menu is locked.

5.14.9 Lock Library

Set the status.

UNLOCKED = the Library menu is not locked.
LOCKED = the Library menu is locked.

5.14.10 Lock I/O Settings

Set the status.

UNLOCKED = the I/O Settings menu is not locked.
LOCKED = the I/O Settings menu is locked.

5.14.11 Factory Reset

Set the status.

UNLOCKED = the Factory Reset menu is not locked.
LOCKED = the Factory Reset menu is locked.

5.15 Securing the Menu and Key Lock menu settings

A slide switch is used to secure the Lock menu settings. When the switch is set to the ON position, the Lock menu settings may be viewed but not changed. This switch is located under the Base.

Set the position of the switch to ON by sliding the external Lock Switch to LOCKED as shown in Section 6.

When the switch is in the ON position, the startup display includes the LOCK ON message.

Note: This switch is also used in conjunction with the Legal for Trade menu item. When the Legal for Trade menu is set to ON, the switch must be set to the ON position to prevent calibration and changes to metrologically significant settings. Refer to Section 6 for more information.

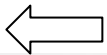

EX12001, EX24001 and EX35001 switch



5.16 Information

Information is available from any application as well as from the Main Menu. A brief description of the item selected is displayed. This feature is menu based.

5.16.1 Using Information



- Touch the Info Icon to bring up the menu (UPPER RIGHT)

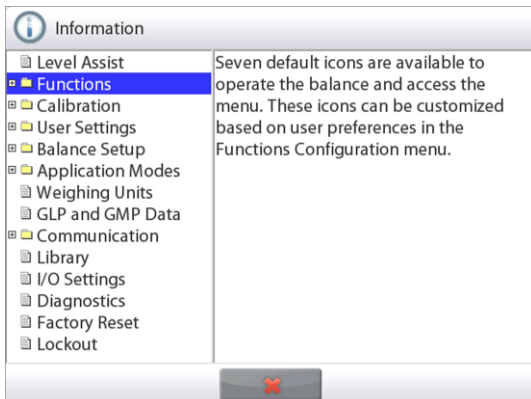

- Information topics, beginning with Level Assist
- Touch the word or the “+” in front of it, to open a topic.
- Touch **X** to close the Information topic.

6. LEGAL FOR TRADE

When the balance is used in trade or a legally controlled application it must be set up, verified and sealed in accordance with local weights and measures regulations. It is the responsibility of the purchaser to ensure that all pertinent legal requirements are met.

6.1 Settings

Before verification and sealing, perform the following steps in Order:

1. Verify that the menu settings meet the local weights and measures regulations.
2. Units menu should be reviewed. Verify the units turned **On** meet the local weights and measures regulations.
3. Perform a calibration as explained in Section 5.
3. Set the position of the Security Switch to the locked position.
4. Set Legal for Trade to ON in the Balance Setup menu.

6.2 Verification

A weights and measures official or authorized service agent must perform the verification procedure.

6.3 Sealing

After the Balance has been verified, it must be sealed to prevent undetected access to the legally controlled settings. Before sealing the device, ensure that the security switch is in the Locked position and the Legal for Trade setting in the Balance Setup menu has been set to ON.

If using a wire seal, pass the sealing wire through the holes in the security switch and Bottom Housing as shown.

If using a paper seal, place the seal over the security switch and Bottom Housing as shown.



Un-Locked



Locked with Wire Seal



Locked with Paper Seal

EX12001, EX24001 and EX35001:



Un-Locked



Locked with Wire Seal



Locked with Paper Seal

7. PRINTING

7.1 Connecting, Configuring and Testing the Printer/Computer Interface

Use the built-in RS-232 Port to connect either to a computer or a printer. If connecting to a computer, use HyperTerminal or similar software. (Find HyperTerminal under **Accessories/Communications** in Windows XP.)

Connect to the computer with a standard (straight-through) serial cable.

Choose **New Connection**, “connect using” COM1 (or available COM port).

Select **Baud=9600; Parity=8 None; Stop=1; Handshaking=None**. Click **OK**.

Choose Properties/Settings, then ASCII Setup. Check boxes as illustrated:

(**S**end line ends...; **E**cho typed characters...; **W**rap lines...)

Use RS232 Interface Commands (Section 9.6.1) to control the balance from a PC.

Note: When the HyperTerminal configuration is complete, it will automatically print the results of a **Cal Test** operation, and echo print commands sent to the scale.

Printer Connection

Two printers compatible with Explorer Balances are available from Ohaus. (See Section 9.) Connect a straight-through serial cable to the scale's RS232 port.

See sample Print Output Formats below. Two printers compatible with explorer balances are available from Ohaus. Connect a straight through serial cable to the scale

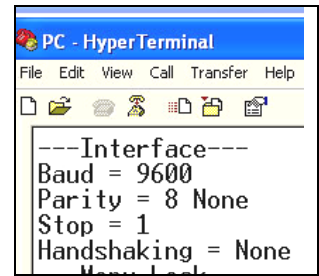

7.2 Printout Examples

Examples for each Application are shown with all items turned **ON** in the **Print Content** menu. The default values for **Header** lines 1-5 are also shown.

Note: If a Library name has been selected, "Library Name:" will appear below "Application" in the printout.

Weighing
Company Name
Address 1
Address 2
Address 3
Address 4
12/7/2010 3:00 PM
Balance ID:
Balance Name: EXPLORER
User Name:
Project Name:
Application: Weighing
Result: 2.771 g Net
Gross: 4.148 g
Net: 2.771 g Net
Tare: 1.377 g T
Minimum Weight: 0.000 g
Signature: _____
Verified by: _____

Weighing->Statistics
Company Name
Address 1
Address 2
Address 3
Address 4
12/7/2010 3:04 PM
Balance ID:
Balance Name: EXPLORER
User Name:
Project Name:
Statistics
Number of Samples: 3
Total: 2.737 g
Average: 0.912 g
Standard Deviation: 0.372 g
Minimum: 0.457 g
Maximum: 1.369 g
Difference: 0.912 g
Signature: _____
Verified by: _____

Parts Counting->Standard
Company Name
Address 1
Address 2
Address 3
Address 4
12/7/2010 3:20 PM
Balance ID:
Balance Name: EXPLORER
User Name:
Project Name:
Application: Parts Counting
Quantity: 3 PCS Net
Gross: 2.325 g
Net: 1.379 g Net
Tare: 0.946 g T
APW: 0.4551 g
Samples: 1 PCS
Signature: _____
Verified by: _____

Parts Counting->Check
Company Name
Address 1
Address 2
Address 3
Address 4
12/7/2010 3:21 PM
Balance ID:
Balance Name: EXPLORER
User Name:
Project Name:
Application: Check Counting
Quantity: 3 PCS Net
Status: Under
Gross: 2.323 g
Net: 1.377 g Net
Tare: 0.946 g T
APW: 0.4551 g
Samples: 1 PCS
Over Limit: 30 PCS
Under Limit: 10 PCS
Signature: _____
Verified by: _____

Parts Counting→Fill

Company Name
Address 1
Address 2
Address 3
Address 4
12/7/2010 3:23 PM
Balance ID:
Balance Name: EXPLORER
User Name:
Project Name:
Application: Fill Counting
Quantity: 3 PCS Net
Gross: 2.324 g
Net: 1.378 g Net
Tare: 0.946 g T
APW: 0.4551 g
Samples: 1 PCS
Target: 4 PCS
Difference: -1 PCS
Signature: _____
Verified by: _____

Parts Counting→Statistics

Company Name
Address 1
Address 2
Address 3
Address 4
12/7/2010 3:11 PM
Balance ID:
Balance Name: EXPLORER
User Name:
Project Name:
Statistics
Number of Samples: 3
Total: 6 PCS
Average: 2 PCS
Standard Deviation: 1 PCS
Minimum: 1 PCS
Maximum: 3 PCS
Difference: 2 PCS
Signature: _____
Verified by: _____

Percent Weighing

Company Name
Address 1
Address 2
Address 3
Address 4
12/7/2010 3:27 PM
Balance ID:
Balance Name: EXPLORER
User Name:
Project Name:
Application: Percent Weigh
Percentage: 91 % Net
Gross: 1.401 g
Net: 0.455 g Net
Tare: 0.946 g T
Reference: 0.500 g
Reference Adjust: 100 %
Difference: -0.045 g
Difference: -9.00 %
Signature: _____
Verified by: _____

Check Weigh→Over Under
Company Name
Address 1
Address 2
Address 3
Address 4
12/7/2010 3:32 PM
Balance ID:
Balance Name: EXPLORER
User Name:
Project Name:
Application: Check Weighing
Result: Accept
Gross: 1.401 g
Net: 0.455 g Net
Tare: 0.946 g T
Over Limit: 619.999 g
Under Limit: 0.010 g
Signature: _____
Verified by: _____

Check Weigh→ Nom, Wt Tol
Company Name
Address 1
Address 2
Address 3
Address 4
12/7/2010 3:34 PM
Balance ID:
Balance Name: EXPLORER
User Name:
Project Name:
Application: Check Weighing
Result: Under
Gross: 1.401 g
Net: 0.455 g Net
Tare: 0.946 g T
Target: 310.000 g
+ Tolerance (wt.): 155.000 g
- Tolerance (wt.): 155.000 g
Signature: _____
Verified by: _____

Check Weigh→ Nom, % Tol
Company Name
Address 1
Address 2
Address 3
Address 4
12/7/2010 3:35 PM
Balance ID:
Balance Name: EXPLORER
User Name:
Project Name:
Application: Check Weighing
Result: Under
Gross: 1.399 g
Net: 0.453 g Net
Tare: 0.946 g T
Target: 310.000 g
+ Tolerance (%): 50.00 %
- Tolerance (%): 50.00 %
Signature: _____
Verified by: _____

Check Weighing→Statistics
Company Name
Address 1
Address 2
Address 3
Address 4
12/7/2010 3:37 PM
Balance ID:
Balance Name: EXPLORER
User Name:
Project Name:
Statistics
Number of Samples: 3
Total: 2.725 g
Average: 0.908 g
Standard Deviation: 0.372 g
Minimum: 0.453 g
Maximum: 1.364 g
Difference: 0.911 g
Signature: _____
Verified by: _____

Note: In order to print Net weight, the Tare key needs to be pressed.

Dynamic Weighing

Company Name
 Address 1
 Address 2
 Address 3
 Address 4
 12/7/2010 3:38 PM
 Balance ID:
 Balance Name: EXPLORER
 User Name:
 Project Name:
 Application: Dynamic Weigh
 Averaging Time: 10 seconds
 Gross: 2.310 g
 Net: 1.364 g Net
 Tare: 0.946 g T
 Final weight: 12.643 g
 Signature: _____
 Verified by: _____

Dynamic→Statistics

Company Name
 Address 1
 Address 2
 Address 3
 Address 4
 12/7/2010 3:41 PM
 Balance ID:
 Balance Name: EXPLORER
 User Name:
 Project Name:
 Statistics
 Number of Samples: 3
 Total: 181.092 g
 Average: 60.364 g
 Standard Deviation: 40.027 g
 Minimum: 31.404 g
 Maximum: 116.966 g
 Difference: 85.563 g
 Signature: _____
 Verified by: _____

Filling

Company Name
 Address 1
 Address 2
 Address 3
 Address 4
 12/7/2010 3:42 PM
 Balance ID:
 Balance Name: EXPLORER
 User Name:
 Project Name:
 Application: Filling
 Result: 1.825 g Net
 Gross: 2.771 g
 Net: 1.825 g Net
 Tare: 0.946 g T
 Target: 10.000 g
 Diff Weight g: -8.175 g
 Diff Percent %: -81.8 %
 Signature: _____
 Verified by: _____

Filling→Statistics

Company Name
 Address 1
 Address 2
 Address 3
 Address 4
 12/7/2010 3:44 PM
 Balance ID:
 Balance Name: EXPLORER
 User Name:
 Project Name:
 Statistics
 Number of Samples: 3
 Total: 5.021 g
 Average: 1.674 g
 Standard Deviation: 0.435 g
 Minimum: 1.366 g
 Maximum: 2.289 g
 Difference: 0.923 g
 Signature: _____
 Verified by: _____

Totalization	
Company Name	
Address 1	
Address 2	
Address 3	
Address 4	
12/7/2010 3:46 PM	
Balance ID:	
Balance Name: EXPLORER	
User Name:	
Project Name:	
Application: Totalization	
Total:	30.1479 g
Samples:	4
Average:	7.5370 g
Standard Deviation:	4.0373 g
Minimum:	2.7615 g
Maximum:	13.6798 g
Range:	10.9183 g
*----Sample Data (g)----	
1	2.7615
2	5.54885
3	8.2181
4	13.6798
Signature: _____	
Verified by: _____	

Formulation->Recipe	
Company Name	
Address 1	
Address 2	
Address 3	
Address 4	
12/7/2010 3:54 PM	
Balance ID:	
Balance Name: EXPLORER	
User Name:	
Project Name: AURORA	
Application: Formulation	
Total Target:	3.000 g
Total Actual:	5.401 g
Total Diff(%):	80.0 %
Item 3	
Target:	1.000 g
Actual:	1.345 g
Diff(%):	34.5 %
Item 2	
Target:	1.000 g
Actual:	1.800 g
Diff(%):	80.0 %
Item 1	
Target:	1.000 g
Actual:	2.256 g
Diff(%):	125.6 %
Signature: _____	
Verified by: _____	

Formulation->Free Formulat	
Company Name	
Address 1	
Address 2	
Address 3	
Address 4	
12/7/2010 3:50 PM	
Balance ID:	
Balance Name: EXPLORER	
User Name: xiao	
Project Name: AURORA	
Application: Formulation	
Result:	1.345 g Net
Gross:	2.291 g
Net:	1.345 g Net
Tare:	0.946 g T
Item 1:	1.833 g
Item 2:	0.888 g
Item 3:	1.344 g
Total:	4.065 g
Signature: _____	
Verified by: _____	

Differential

Company Name
Address 1
Address 2
Address 3
Address 4
12/7/2010 3:57 PM
Balance ID:
Balance Name: EXPLORER
User Name:
Project Name:
Application: Differential
Item Name:
Result: 1.341 g Net
Gross: 2.287 g
Net: 1.341 g Net
Tare: 0.946 g T

Item Name: Item 3
Initial wt.: 1.338 g
Final wt.: 1.343 g
Difference: -0.005 g
Difference: -0.4 %
Signature: _____
Verified by: _____

Peak Hold

Company Name
Address 1
Address 2
Address 3
Address 4
12/7/2010 4:00 PM
Balance ID:
Balance Name: EXPLORER
User Name:
Project Name:
Application: Peak Hold
Peak weight: 115.722 g
Gross: 0.921 g
Net: -0.025 g Net
Tare: 0.946 g T
On Stability: No
Signature: _____
Verified by: _____

Density Determination

Company Name
Address 1
Address 2
Address 3
Address 4
12/7/2010 4:01 PM
Balance ID:
Balance Name: EXPLORER
User Name:
Project Name:
Application: Density (Solid)
Density Determ: 1.9668 g/cm³
Gross: 1.832 g
Net: 0.886 g Net
Tare: 0.946 g T
Weight in air: 1.799 g
Weight in liquid: 0.886 g
Auxiliary liquid: Water
Water Temp.: 20.0 C
Porous Material: Off
Signature: _____
Verified by: _____

Pipette Adjustment

Company Name
 Address 1
 Address 2
 Address 3
 Address 4
 12/7/2010 4:04 PM
 Balance ID:
 Balance Name: EXPLORER
 User Name:
 Project Name:
 Application: Pipette Adjust
 Result: Fail

Pipette Name:
 Pipette Number:
 Nominal Volume: 10.0ml
 Liquid Density: 0.9982g/cm³
 Water Temp.: 20
 Pressure: 1.0 ATM

Inaccuracy
 E%: 72.47%
 E%: Limit: 0.00%
 Average: 2.75ml

Imprecision
 CV%: 0.72%
 CV% Limit: 0.00%
 Standard Deviation: 0.02ml

Number of Samples: 2
 > +2S: 0.00%, 0
 > +1S: 0.00%, 0
 *+1S > Mean > -1S: 100.00%, 2
 < -1S: 0.00%, 0
 < -2S: 0.00%, 0
 *----Sample Data (g)----

1 2.7
 2 2.8

Signature: _____

Verified by: _____

Ingredient Costing

Company Name
 Address 1
 Address 2
 Address 3
 Address 4
 12/7/2010 4:09 PM
 Balance ID:
 Balance Name: EXPLORER
 User Name:
 Project Name:
 Application: Ingredient Cost

Total Items: 4
 Total Weight: 4.570 g
 Total Cost: 13.73 \$

Item 1
 Item Weight: 0.454 g
 Unit Cost: 1.00 \$/g
 Item's Total Cost: 0.45 \$

Item 2
 Item Weight: 0.910 g
 Unit Cost: 2.00 \$/g
 Item's Total Cost: 1.82 \$

Signature: _____

Verified by: _____

SQC

Company Name

Address 1

Address 2

Address 3

Address 4

12/7/2010 4:14 PM

Balance ID:

Balance Name: EXPLORER

User Name:

Project Name:

Application: SQC

Batch Name: Water

Samples: 2

Unit : g

Nominal Weight: 160.0000 g

Average: 4.1296 g

Maximum: 5.4962 g

Minimum: 2.7629 g

Standard Deviation: 1.3666 g

Range: 2.7333 g

> +2T: 0.00 %, 0

> +1T: 0.00 %, 0

*+1T > N > -1T: 0.00 %, 2

< -1T: 0.00 %, 0

< -2T: 0.00 %, 0

*----Sample Data (g)----

1 2.7629

2 5.4962

Signature: _____

Verified by: _____

Span Calibration and User Calibration:

Content
HEADER 1
HEADER 2
HEADER 3
HEADER 4
HEADER 5
TIME
RESULT
RESULT
RESULT
RESULT
RESULT

Span Calibration
Company Name
Address 1
Address 2
Address 3
Address 4
12/6/2010 4:33 AM
---Span Calibration---
Balance ID:
Balance Name: EXPLORER
User Name:
Project Name:
New Calibration: 1999.99 g
Old Calibration: 2000.00 g
Difference: 0.01 g
Weight ID _____
Signature: _____
Verified by: _____
-----End-----

User Calibration
Company Name
Address 1
Address 2
Address 3
Address 4
12/6/2010 4:36 AM
---User Calibration---
Balance ID:
Balance Name: EXPLORER
User Name:
Project Name:
New Calibration: 1999.99 g
Old Calibration: 2000.00 g
Difference: 0.01 g
Weight ID _____
Signature: _____
Verified by: _____
-----End-----

The **CAL TEST** printout is automatically printed when a Calibration Test is performed.

Content
HEADER 1
HEADER 2
HEADER 3
HEADER 4
HEADER 5
TIME
RESULT
RESULT
RESULT
RESULT
RESULT

Calibration Test
Company Name
Address 1
Address 2
Address 3
Address 4
12/6/2010 4:33 AM
---Calibration test---
New Calibration: 3999.97 g
Old Calibration: 4000.00 g
Difference: 0.03 g
Weight ID _____
-----End-----

7.3 Output Format

The Result Data, and G/N/T data, is output in the following format.

Field:	Label ¹	Space ²	Weight ³	Space ²	Unit ⁴	Space	Stability ⁵	Space	G/N ⁶	Space	Term. Characters ⁷
Length:		1	11	1		1	≤ 1	≤ 1	≤ 3	0	≤ 8

1. In certain cases, a Label field of up to 11 characters is included.
2. Each field is followed by a single delimiting space (ASCII 32).
3. The Weight field is 9 right justified characters. If the value is negative, the “-” character is located at the immediate left of the most significant digit.
4. The Unit field contains the unit of measure abbreviation up to 5 characters.
5. The Stability field contains the “?” character if the weight reading is not stable. The Stability field and the following Space field are omitted if the weight reading is stable.
6. The G/N field contains the net or gross indication. For net weights, the field contains “NET”. For gross weights, the field contains nothing, “G” or “B”, depending on the GROSS INDICATOR menu setting.
7. The Termination Characters field contains CRLF, Four CRLF or Form Feed (ASCII 12), depending on the LINE FEED menu setting.

8. MAINTENANCE

8.1 Calibration

Periodically verify calibration by placing an accurate weight on the balance and viewing the result. If calibration is required, perform a Balance internal calibration.

8.2 Cleaning



Disconnect the Explorer Balance from the power supply before cleaning. Make sure that no liquid enters the interior of the Terminal or Base.

Clean the Balance at regular intervals.

Housing surfaces may be cleaned with a lint-free cloth slightly dampened with water or a mild cleaning agent.

Glass surfaces may be cleaned with a commercial glass cleaner.

Do not use solvents, harsh chemicals, ammonia or abrasive cleaning agents.

8.3 Troubleshooting

TABLE 8-1. TROUBLESHOOTING

Symptom / Display	Possible Cause	Remedy
Balance will not turn on	No power to Balance	Verify connection and voltage
Poor accuracy	Improper calibration Unstable environment	Perform calibration Move balance to suitable location
Cannot calibrate	Calibration Menu locked LFT set to on Unstable environment Incorrect calibration masses	Turn Calibration menu lock off Turn LFT off Move balance to suitable location Use correct calibration masses
Cannot change menu settings	Sub-menu locked LFT set to on	Unlock sub-menu Turn LFT off
Low Reference weight	Reference weight too small The weight on the pan is too small to define a valid reference weight.	Increase sample size
Invalid Piece Weight	Average piece weight is too small	Increase average piece weight
Operation Timeout	Weight reading is not stable	Move balance to suitable location
-----	Busy (tare, zero, printing)	Wait until completion

8.4 Service Information

If the troubleshooting section does not resolve your problem, contact an Authorized Ohaus Service Agent. Please visit our website www.ohaus.com to locate the Ohaus office nearest you. An Ohaus Product Service Specialist will be available to assist you.

9. TECHNICAL DATA

9.1 Specifications

Ambient conditions

- Indoor use only
- Altitude: Up to 2000 m
- Specified Temperature range: 10°C to 30°C
- Humidity: maximum relative humidity 80 % for temperatures up to 30°C decreasing linearly to 50% relative humidity at 40°C
- Mains supply voltage fluctuations: up to $\pm 10\%$ of the nominal voltage
- Installation category II
- Pollution degree: 2

Materials

- Base Housing; die-cast Aluminum, Painted
- Base: IP54 waterproof protected (EX12001, EX24001 and EX35001)
- Top Housing, Base, Terminal: plastic (ABS)
- Weighing Platforms: 18/10 stainless steel
- Weighing Pan: 304 SST (EX12001, EX24001 and EX35001)
- In-use Cover, Terminal: plastic (PET)
- Draft Shield; Glass, plastic (ABS)

TABLE 9-1. SPECIFICATIONS

MODEL	EX124	EX224	EX324
Capacity	120 g	220 g	320 g
Readability d	0.1 mg		
Repeatability (std. dev.) (g)	0.0001 g		
Linearity (g)	± 0.0002 g		
Span Calibration Points (g)	50g, 100g	100g, 150g, 200g	150g, 200g, 300g
Weighing units	Baht, carat, grain, gram, kilogram, milligram, mesghal, momme, Newton, ounce, pennyweight, pound, Tael (Hong Kong), Tael (Singapore), Tael (Taiwan), tical, tola, troy ounce, custom (3)		
Applications	Weighing, Parts Counting, Percent Weighing, Check Weighing, Dynamic Weighing, Filling, Totalization, Formulation, Differential Weighing, Peak Hold, Density Determination, Pipette Adjustment, Ingredient Costing, Statistical Quality Control		
Stabilization time (typical)	Within 2 seconds		Within 3 seconds
Sensitivity Temperature Drift (PPM/°C)	1.5	1.5	1.5
Typical Operating Range USP (u=0.1%,k=2)	0.16g-120g	0.16g-220g	0.16g-320g
Optimal Operating Range USP (u=0.1%,k=2)	0.082g-120g	0.082g-220g	0.082g-320g
Display	Full-Color VGA Graphic LCD		
Display size	5.7 in / 14.5 cm (diagonal)		
Backlight	White LED		
Controls	4-wire resistive touch screen		
Communication	RS-232, USB		
Balance power input	12 VDC, 0.5A		
Power supply	AC Adapter Input: 100-240 VAC 0.6A 50-60 Hz AC Adapter Output: 12 VDC 1.5A		
Platform size (diameter)	90 mm 3.5 in		
Terminal Housing dimensions (W x D x H)	195 x 155 x 68 mm 7.7 x 6.1 x 2.7 inch		
Base Housing dimensions (W x D x H)	230 x 260 x 350 mm 9.1 x 10.2 x 13.8 inch		
Assembled dimensions (W x D x H)	230 x 393 x 350 mm 9.1 x 15.5 x 13.8 inch		
Net weight	6.9 kg 15.2 lb		
Shipping weight	9.7 kg 21.3 lb		
Shipping dimension	550 x 385 x 551 mm 21.7 x 15.2 x 21.7 inch		

Note: Default Calibration weights shown in Bold

TABLE 9-2. SPECIFICATIONS (Cont.)

MODEL	EX223	EX423	EX623	EX1103
Capacity	220 g	420 g	620 g	1100 g
Readability d	0.001 g			
Repeatability (std. dev.)	0.001 g			
Linearity	± 0.002 g			
Span Calibration Points	100g, 150g, 200g	200g, 300g, 400g	300g, 400g, 500g , 600g	500g, 1000g
Weighing units	Baht, carat, grain, gram, kilogram, milligram, mesghal, momme, Newton, ounce, pennyweight, pound, Tael (Hong Kong), Tael, (Singapore), Tael (Taiwan), tical, tola, troy ounce, custom (3)			
Applications	Weighing, Parts Counting, Percent Weighing, Check Weighing, Dynamic Weighing, Filling, Totalization, Formulation, Differential Weighing, Peak Hold, Density Determination, Pipette Adjustment, Ingredient Costing, Statistical Quality Control			
Stabilization time (typical)	Within 1.5 seconds			
Sensitivity Temperature Drift (PPM/°C)	3	3	3	3
Typical Operating Range USP (u=0.1%,k=2)	1.6g-220g	1.6g-420g	1.6g-620g	1.6g-1100g
Optimal Operating Range USP (u=0.1%,k=2)	0.82g-220g	0.82g-420g	0.82g-620g	0.82-1100g
Display	Full-Color VGA Graphic LCD			
Display size	5.7 in / 14.5 cm (diagonal)			
Backlight	White LED			
Controls	4-wire resistive touch screen			
Communication	RS-232, USB			
Balance power input	12 VDC, 0.5A			
Power supply	AC Adapter Input : 100-240 VAC 0.6A 50-60 Hz AC Adapter Output : 12 VDC 1.5A			
Platform size (diameter)	130 mm 5.1 in			
Terminal Housing dimensions (W x D x H)	195 x 155 x 68 mm 7.7 x 6.1 x 2.7 inch			
Base Housing dimensions (W x D x H)	230 x 260 x 350 mm 9.1 x 10.2 x 13.8 inch			
Assembled dimensions (W x D x H)	230 x 393 x 350 mm 9.1 x 15.5 x 13.8 inch			
Net weight	6.9 kg 15.2 lb			
Shipping weight	9.7 kg 21.3 lb			
Shipping dimension	550 x 385 x 551 mm 21.7 x 15.2 x 21.7 inch			

Note: Default Calibration weights shown in Bold

TABLE 9-3. SPECIFICATIONS (Cont.)

MODEL	EX2202	EX4202	EX6202	EX10202
Capacity	2200 g	4200 g	6200 g	10200 g
Readability d	0.01 g			
Repeatability (std. dev.)	0.01 g			
Linearity	± 0.02 g			
Span Calibration Points	1000g, 2000g	2000g, 3000g, 4000g	3000g, 4000g, 5000g , 6000g	2500g, 5000g, 7500g, 10,000g
Weighing units	Baht, carat, grain, gram, kilogram, mesghal, momme, Newton, ounce, pennyweight, pound, Tael (Hong Kong), Tael, (Singapore), Tael (Taiwan), tical, tola, troy ounce, custom (3)			
Applications	Weighing, Parts Counting, Percent Weighing, Check Weighing, Dynamic Weighing, Filling, Totalization, Formulation, Differential Weighing, Peak Hold, Density Determination, Pipette Adjustment, Ingredient Costing, Statistical Quality Control			
Stabilization time (typical)	Within 1 second			
Sensitivity Temperature Drift (PPM/°C)	3	3	3	3
Typical Operating Range USP (u=0.1%,k=2)	16g-2200g	16g-4200g	16g-6200g	16g-10200g
Optimal Operating Range USP (u=0.1%,k=2)	8.2g-2200g	8.2g-4200g	8.2g-6200g	8.2g-10200g
Display	Full-Color VGA Graphic LCD			
Display size	5.7 in / 14.5 cm (diagonal)			
Backlight	White LED			
Controls	4-wire resistive touch screen			
Communication	RS-232, USB			
Balance power input	12 VDC, 0.5A			
Power supply	AC Adapter Input: 100-240 VAC 0.6A 50-60 Hz AC Adapter Output: 12 VDC 1.5A			
Platform size	190 x 200 mm 7.5 x 8.0 in			
Terminal Housing dimensions (W x D x H)	195 x 155 x 68 mm 7.7 x 6.1 x 2.7 inch			
Base Housing dimensions (W x D x H)	230 x 260 x 98 mm 9.1 x 10.2 x 3.9 inch			
Assembled dimensions (W x D x H)	230 x 393 x 98 mm 9.1 x 15.5 x 3.9 inch			
Net weight	4.3 kg / 9.5 lb		5.0 kg / 11.0 lb	
Shipping weight	6.8 kg / 15.0 lb		7.5 kg / 16.5 lb	
Shipping dimensions	550 x 385 x 291 mm 21.7 x 15.2 x 11.5 inch			

Note: Default Calibration weights shown in Bold

TABLE 9-4. SPECIFICATIONS (Cont.)

MODEL	EX6201	EX10201
Capacity	6200 g	10200 g
Readability d	0.1 g	
Repeatability (std. dev.)	0.1 g	
Linearity	± 0.2 g	
Span Calibration Points	3000g, 4000g, 5000g , 6000g	2500g, 5000g, 7500g, 10,000g
Weighing units	Baht, carat, grain, gram, kilogram, mesghal, momme, Newton, ounce, pennyweight, pound, Tael (Hong Kong), Tael, (Singapore), Tael (Taiwan), tical, tola, troy ounce, custom (3)	
Applications	Weighing, Parts Counting, Percent Weighing, Check Weighing, Dynamic Weighing, Filling, Totalization, Formulation, Differential Weighing, Peak Hold, Density Determination, Pipette Adjustment, Ingredient Costing, Statistical Quality Control	
Stabilization time (typical)	Within 1 second	
Sensitivity Temperature Drift (PPM/°C)	5	3
Typical Operating Range USP (u=0.1%,k=2)	160g-6200g	160g-10200g
Optimal Operating Range USP (u=0.1%,k=2)	82g-6200g	82g-10200g
Display	Full-Color VGA Graphic LCD	
Display size	5.7 in / 14.5 cm (diagonal)	
Backlight	White LED	
Controls	4-wire resistive touch screen	
Communication	RS-232, USB	
Balance power input	12 VDC, 0.5A	
Power supply	AC Adapter Input: 100-240 VAC 0.6A 50-60 Hz AC Adapter Output: 12 VDC 1.5A	
Platform size	190 x 200 mm 7.5 x 8.0 in	
Terminal Housing dimensions (W x D x H)	195 x 155 x 68 mm 7.7 x 6.1 x 2.7 inch	
Base Housing dimensions (W x D x H)	230 x 260 x 98 mm 9.1 x 10.2 x 3.9 inch	
Assembled dimensions (W x D x H)	230 x 393 x 98 mm 9.1 x 15.5 x 3.9 inch	
Net weight	5.0 kg 11.0 lb	
Shipping weight	7.5 kg 16.5 lb	
Shipping dimensions	550 x 385 x 291 mm 21.7 x 15.2 x 11.5 inch	

Note: Default Calibration weights shown in Bold

TABLE 9-5. SPECIFICATIONS (Cont.)

MODEL	EX224x ¹	EX324x ¹	EX423x ¹	EX1103x ¹
Max	220 g	320 g	420 g	1100 g
Min	0.01 g	0.01 g	0.02 g	0.1 g
d =	0.0001 g	0.0001 g	0.001 g	0.001 g
e =	0.001 g	0.001 g	0.01 g	0.01 g
Approval Class	I	I	II	I
Repeatability (std. dev.)	0.0001 g		0.001 g	
Linearity	± 0.0002 g		± 0.002 g	
Span Calibration Points	100g, 150g, 200g	150g, 200g, 300g	200g, 300g, 400g	500g, 1000g
Weighing units	M-Models: milligram, gram, carat N-Models: gram, milligram, carat, pennyweight, grain, ounce, troy ounce			
Applications	Weighing, Parts Counting, Percent Weighing, Check Weighing, Dynamic Weighing, Filling, Totalization, Formulation, Differential Weighing, Peak Hold, Density Determination, Pipette Adjustment, Ingredient Costing, Statistical Quality Control			
Stabilization time (typical)	Within 2 seconds	Within 3 seconds	Within 1.5 seconds	
Sensitivity Temperature Drift (PPM/°C)	1.5	1.5	3	3
Typical Operating Range USP (u=0.1%,k=2)	0.16g-220g	0.16g-320g	1.6g-420g	1.6g-1100g
Optimal Operating Range USP (u=0.1%,k=2)	0.082g-220g	0.082g-320g	0.82g-420g	0.82-1100g
Display	Full-Color VGA Graphic LCD			
Display size	5.7 in / 14.5 cm (diagonal)			
Backlight	White LED			
Controls	4-wire resistive touch screen			
Communication	RS-232, USB			
Balance power input	12 VDC, 0.5A			
Power supply	AC Adapter Input : 100-240 VAC 0.6A 50-60 Hz AC Adapter Output : 12 VDC 1.5A			
Platform size	90 mm 3.5 in	130 mm 5.1 in		
Terminal Housing dimensions (W x D x H)	195 x 155 x 68 mm 7.7 x 6.1 x 2.7 inch			
Base Housing dimensions (W x D x H)	230 x 260 x 350 mm 9.1 x 10.2 x 13.8 inch			
Assembled dimensions (W x D x H)	230 x 393 x 350 mm 9.1 x 15.5 x 13.8 inch			
Net weight	6.9 kg 15.2 lb		7.5 kg 16.5 lb	
Shipping weight	9.7 kg 21.3 lb		10.3 kg 22.7 lb	
Shipping dimensions	550 x 385 x 551 mm 21.7 x 15.2 x 21.7 inch			

Note 1: M = EC Type approved

N = NTEP certified and Measurement Canada approved

Note 2: Default Calibration weights shown in Bold

TABLE 9-6. SPECIFICATIONS (Cont.)

MODEL	EX4202x ¹	EX10202x ¹	EX10201x ¹
Max	4200 g	10200 g	10200 g
Min	0.5 g	1 g	10 g
d =	0.01 g	0.01 g	0.1 g
e =	0.1 g	0.1 g	0.1 g
Approval Class	II	I	I
Repeatability (std. dev.)	0.01 g		0.1 g
Linearity	±0.02 g		±0.2 g
Span Calibration Points	2000g, 3000g, 4000g	2500g, 5000g, 7500g, 10,000g	2500g, 5000g, 7500g, 10,000g
Weighing units	M-Models:kilogram, gram, carat N-Models: gram, kilogram, carat, pennyweight, grain, pound, ounce, troy ounce		
Applications	Weighing, Parts Counting, Percent Weighing, Check Weighing, Dynamic Weighing, Filling, Totalization, Formulation, Differential Weighing, Peak Hold, Density Determination, Pipette Adjustment, Ingredient Costing, Statistical Quality Control		
Stabilization time (typical)	Within 1 second		
Sensitivity Temperature Drift (PPM/°C)	3		
Typical Operating Range USP (u=0.1%,k=2)	16g-4200g	16g-10200g	160g-10200g
Optimal Operating Range USP (u=0.1%,k=2)	8.2g-4200g	8.2g-10200g	82g-10200g
Display	Full-Color VGA Graphic LCD		
Display size	5.7 in / 14.5 cm (diagonal)		
Backlight	White LED		
Controls	4-wire resistive touch screen		
Communication	RS-232, USB		
Balance power input	12 VDC, 0.5A		
Power supply	AC Adapter Input: 100-240 VAC 0.6A 50-60 Hz AC Adapter Output: 12 VDC 1.5A		
Platform size	190 x 200 mm 7.5 x 8.0 in		
Terminal Housing dimensions (W x D x H)	195 x 155 x 68 mm 7.7 x 6.1 x 2.7 inch		
Base Housing dimensions (W x D x H)	230 x 260 x 98 mm 9.1 x 10.2 x 3.9 inch		
Assembled dimensions (W x D x H)	230 x 393 x 98 mm 9.1 x 15.5 x 3.9 inch		
Net weight	4.3 kg / 9.5 lb		5.0 kg / 11.0 lb
Shipping weight	6.8 kg / 15.0 lb		7.5 kg / 16.5 lb
Shipping dimensions	550 x 385 x 291 mm 21.7 x 15.2 x 11.5 inch		

Note 1: M = EC Type approved

N = NTEP certified and Measurement Canada approved

Note 2: Default Calibration weights shown in Bold

TABLE 9-7. SPECIFICATIONS

MODEL	EX124x ¹ /AD	EX224x ¹ /AD	EX324x ¹ /AD
Capacity	120 g	220 g	320 g
Readability d	0.0001 g		
Repeatability	0.0001 g		
Linearity	± 0.0002 g		
Span Calibration Points	25g, 50g, 75g 100g	50g, 100g, 150g, 200g	100, 150g, 200g, 300g
Calibration	AutoCal™		
Weighing units	Baht, carat, grain, gram, kilogram, mesghal, momme, Newton, ounce, pennyweight, pound, Tael (Hong Kong), Tael, (Singapore), Tael (Taiwan), tical, tola, troy ounce, custom (3)		
Applications	Weighing, Parts Counting, Percent Weighing, Check Weighing, Dynamic Weighing, Filling, Totalization, Formulation, Differential Weighing, Peak Hold, Density Determination, Pipette Adjustment, Ingredient Costing, Statistical Quality Control		
Stabilization time	≤ 4 seconds		
Automatic Door	Motorized door operated by 4 sensors		
Sensitivity Temperature Drift (PPM/ °C)	1.5	1.5	1.5
Typical Operating Range USP (u=0.1%,k=2)	0.16g-120g	0.16g-220g	0.16g-320g
Optimal Operating Range USP (u=0.1%,k=2)	0.082g-120g	0.082g-220g	0.082g-320g
Display	Full-Color VGA Graphic LCD		
Display size	5.7 in / 14.5 cm (diagonal)		
Backlight	White LED		
Controls	4-wire resistive touch screen		
Communication	RS-232, USB		
Balance power input	12 VDC, 0.5A		
Power supply	AC Adapter Input: 100-240 VAC 0.6A 50-60 Hz AC Adapter Output: 12 VDC 1.5A		
Platform size (diameter)	90 mm 3.5 in		
Terminal Housing dimensions (W x D x H)	195 x 155 x 68 mm 7.7 x 6.1 x 2.7 inch		
Base Housing dimensions (W x D x H)	230 x 260 x 98 mm 9.1 x 10.2 x 3.9 inch		
Assembled dimensions (W x D x H)	229 x 391 x 361 mm 9.0 x 15.4 x 14.2 inch		
Net weight	6.4 kg 14.1 lb		
Shipping weight	9.2 kg 20.3 lb		
Shipping dimensions	550 x 385 x 551 mm 21.7 x 15.2 x 21.7 inch		

Note 1: M = EC Type approved
N = NTEP certified and Measurement Canada approved

Note 2: Default Calibration weights shown in Bold

TABLE 9-8. SPECIFICATIONS

MODEL	EX223/E	EX423/E	EX2202/E	EX4202/E	EX6202/E	EX6201/E
Capacity	220 g	420 g	2200 g	4200 g	6200 g	6200 g
Readability d	0.001 g	0.001 g	0.01 g	0.01 g	0.01 g	0.1 g
Repeatability	0.001 g	0.001 g	0.01 g	0.01 g	0.01 g	0.1 g
Linearity	± 0.002 g	± 0.002 g	± 0.02 g	± 0.02 g	+ 0.02 g	± 0.2 g
Span Calibration Points	100g, 150g, 200g	200g, 300g, 400g	1000g, 2000g	2000g, 3000g, 4000g	3000g, 4000g, 5000g , 6000g	3000g, 4000g, 5000g , 6000g
Calibration	External Calibration					
Weighing units	Baht, carat, grain, gram, kilogram, mesghal, momme, Newton, ounce, pennyweight, pound, Tael (Hong Kong), Tael, (Singapore), Tael (Taiwan), tical, tola, troy ounce, custom (3)					
Applications	Weighing, Parts Counting, Percent Weighing, Check Weighing, Dynamic Weighing, Filling, Totalization, Formulation, Differential Weighing, Peak Hold, Density Determination, Pipette Adjustment, Ingredient Costing, Statistical Quality Control					
Stabilization time	≤ 3 seconds	≤ 2 seconds				
Sensitivity Temperature Drift (PPM/ °C)	3	3	3	3	3	3
Typical Operating Range USP (u=0.1%,k=2)	1.6g-220g	1.6g-420g	16g-2200g	16g-4200g	16g-6200g	160g-6200g
Optimal Operating Range USP (u=0.1%,k=2)	0.82g-220g	0.82g-420g	8.2g-2200g	8.2g-4200g	8.2g-6200g	82g-6200g
Display	Full-Color VGA Graphic LCD					
Display size	5.7 in / 14.5 cm (diagonal)					
Backlight	White LED					
Controls	4-wire resistive touch screen					
Communication	RS-232, USB					
Balance power input	12 VDC, 0.5A					
Power supply	AC Adapter Input: 100-240 VAC 0.6A 50-60 Hz AC Adapter Output: 12 VDC 1.5A					
Platform size	190 x 200 mm 7.5 x 8.0 in					
Terminal Housing dimensions (W x D x H)	195 x 155 x 68 mm 7.7 x 6.1 x 2.7 inch					
Base Housing dimensions (W x D x H)	230 x 260 x 98 mm 9.1 x 10.2 x 3.9 inch					
Assembled dimensions (W x D x H)	229 x 391 x 350 mm 9.1 x 15.5 x 13.8 inch		229 x 391 x 98 mm 9.0 x 15.4 x 3.9 inch			
Net weight	6.4 kg 14.1 lb	6.4 kg 14.1 lb	4.3 kg 9.5 lb	4.3 kg 9.5 lb	5.0 kg 11.0 lb	5.0 kg 11.0 lb
Shipping weight	9.2 kg 20.3 lb	9.2 kg 20.3 lb	6.8 kg 15.0 lb	6.8 kg 15.0 lb	7.4 kg 16.3 kg	7.4 kg 16.3 kg
Shipping dimensions	550 x 385 x 551 mm 21.7 x 15.2 x 21.7 inch		550 x 385 x 291 mm 21.7 x 15.2 x 11.5 inch			

Note: Default Calibration weights shown in Bold

TABLE 9-9. SPECIFICATIONS

MODEL	EX12001	EX24001	EX35001
Max	12000 g	24000 g	35000 g
Readability d	0.1 g		
Repeatability (std. dev.)	0.1 g		
Linearity	±0.2 g		
Span Calibration Points	3000g, 5000g, 10000g, 12000g	10000g, 15000g, 20000g, 24000g	10000g, 20000g, 30000g, 35000g
Weighing units	kilogram, gram, carat gram, kilogram, carat, pennyweight, grain, pound, ounce, troy ounce		
Applications	Weighing, Parts Counting, Percent Weighing, Check Weighing, Dynamic Weighing, Filling, Totalization, Formulation, Differential Weighing, Peak Hold, Density Determination, Ingredient Costing, Statistical Quality Control		
Stabilization time (typical)	Within 1 second		
Sensitivity Temperature Drift (PPM/°C)	5		
Typical Operating Range USP (u=0.1%,k=2)	160g-12000g	82g-24000g	160g-35001g
Optimal Operating Range USP (u=0.1%,k=2)	82g-12000g	160g-24000g	82g-35000g
Display	Full-Color VGA Graphic LCD		
Display size	5.7 in / 14.5 cm (diagonal)		
Backlight	White LED		
Controls	2-wire resistive touch screen		
Communication	RS-232, USB		
Balance power input	12 VDC, 0.5A		
Power supply	AC Adapter Input: 100-240 V~ 0.5A 50/60 Hz AC Adapter Output: 24 VDC 0.625A		
Platform size	377 x 311 mm 14.8 x 12.2 in		
Terminal Housing dimensions (W x D x H)	195 x 155 x 68 mm 7.7 x 6.1 x 2.7 inch		
Base Housing dimensions (W x D x H)	377 x 311 x 120 mm 14.8 x 12.2 x 4.7 inch		
Assembled dimensions (W x D x H)	442 x 311 x 120 mm 17.4 x 12.2 x 4.7 inch		
Net weight	10 kg / 22 lb		
Shipping weight	12 kg / 26.5 lb		
Shipping dimension	665 x 525 x 330 mm 26.2 x 20.7 x 13.0 inch		

TABLE 9-10. SPECIFICATIONS

MODEL	EX12001x ¹	EX24001x ¹	EX35001x ¹
Max	12000 g	24000 g	35000 g
Min	5g		
d =	0.1 g		
e =	1g		
Approval Class	II		
Repeatability (std. dev.)	0.1 g		
Linearity	±0.2 g		
Span Calibration Points	3000g, 5000g, 10000g, 12000g	10000g, 15000g, 20000g, 24000g	10000g, 20000g, 30000g, 35000g
Weighing units	kilogram, gram, carat gram, kilogram, carat, pennyweight, grain, pound, ounce, troy ounce		
Applications	Weighing, Parts Counting, Percent Weighing, Check Weighing, Dynamic Weighing, Filling, Totalization, Formulation, Differential Weighing, Peak Hold, Density Determination, Ingredient Costing, Statistical Quality Control		
Stabilization time (typical)	Within 1 second		
Sensitivity Temperature Drift (PPM/°C)	5		
Typical Operating Range USP (u=0.1%,k=2)	160g-12000g	82g-24000g	160g-35001g
Optimal Operating Range USP (u=0.1%,k=2)	82g-12000g	160g-24000g	82g-35000g
Display	Full-Color VGA Graphic LCD		
Display size	5.7 in / 14.5 cm (diagonal)		
Backlight	White LED		
Controls	1-wire resistive touch screen		
Communication	RS-232, USB		
Balance power input	12 VDC, 0.5A		
Power supply	AC Adapter Input: 100-240 V~ 0.5A 50/60 Hz AC Adapter Output: 24 VDC 0.625A		
Platform size	377 x 311 mm 14.8 x 12.2 in		
Terminal Housing dimensions (W x D x H)	195 x 155 x 68 mm 7.7 x 6.1 x 2.7 inch		
Base Housing dimensions (W x D x H)	377 x 311 x 120 mm 14.8 x 12.2 x 4.7 inch		
Assembled dimensions (W x D x H)	442 x 311 x 120 mm 17.4 x 12.2 x 4.7 inch		
Net weight	10 kg / 22 lb		
Shipping weight	12 kg / 26.5 lb		
Shipping dimension	665 x 525 x 330 mm 26.2 x 20.7 x 13.0 inch		

Note 1: M = EC Type approved

9.2 Drawings and Dimensions

Fully assembled dimensions

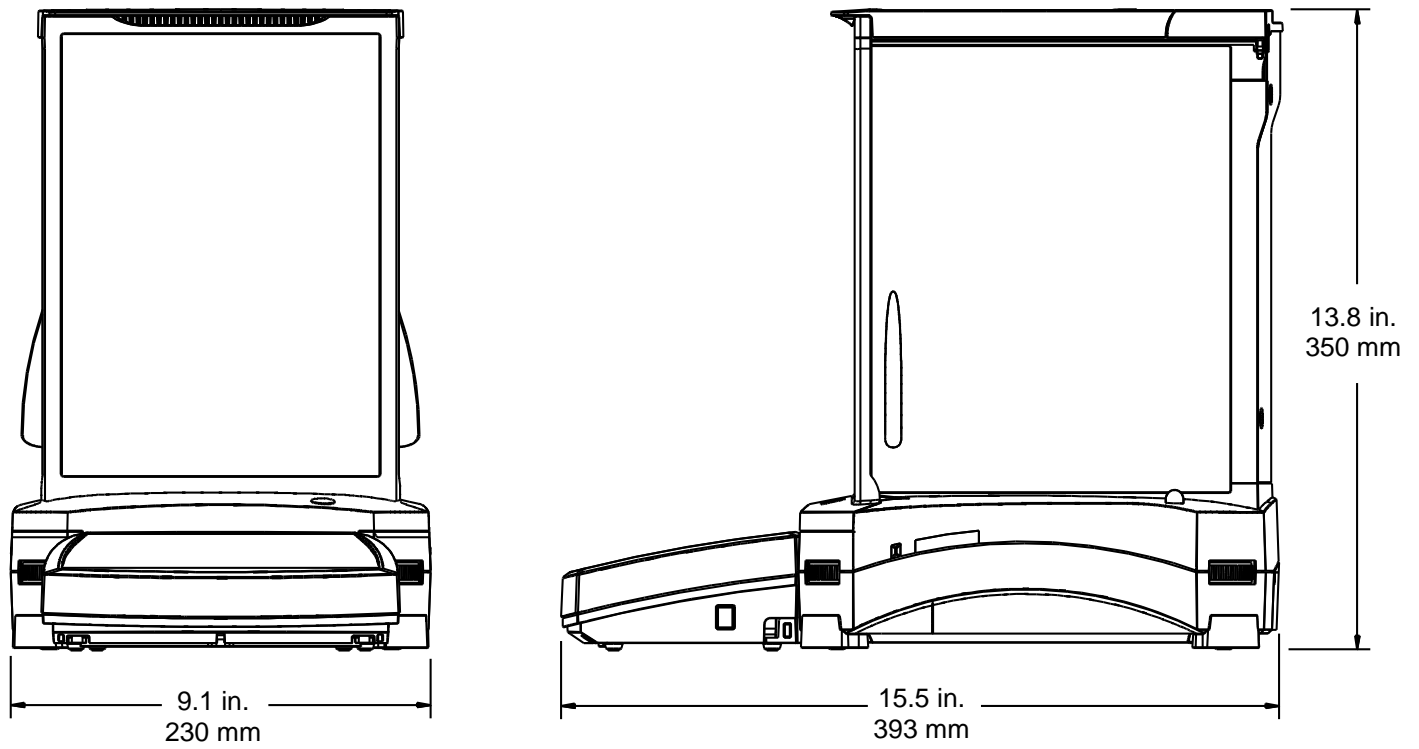

Figure 9-1. Draft Shield models

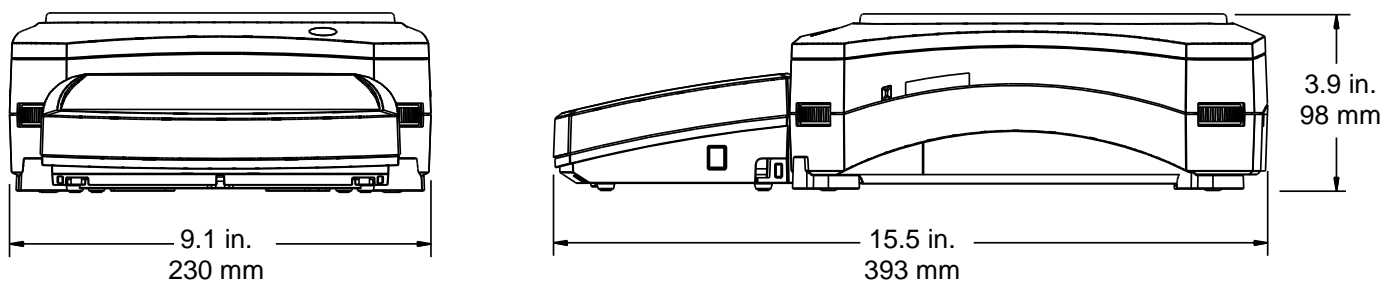

Figure 9-2. Non-Draft Shield models

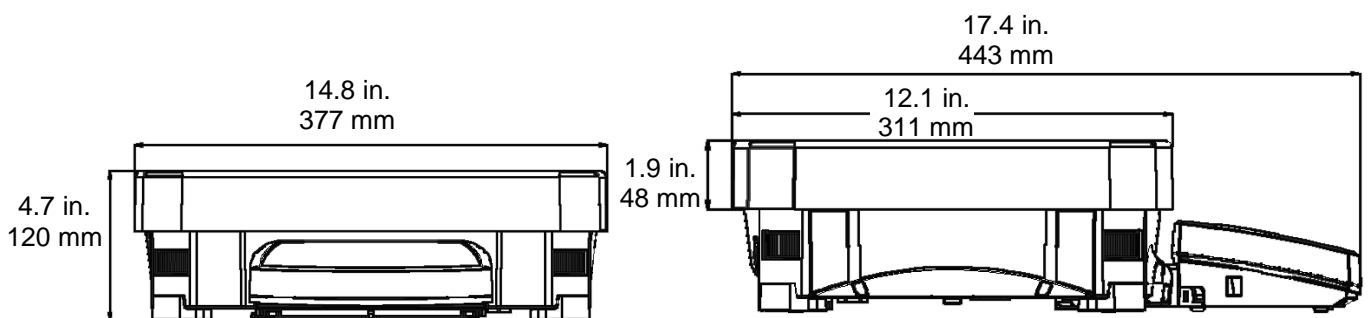

Figure 9-3. EX12001, EX24001 and EX35001 models

9.3 Parts and Accessories

TABLE 9-7. PARTS

DESCRIPTION	PART NUMBER
Terminal in-use Cover	83033633
Universal AC Adapter (without power Cord)	46001884
Power Cord US	83033672
Power Cord EU	83033673
Power Cord UK	83033674
Power Cord AU	83033675
Power Cord JP	83033676
90 mm Pan Assembly	83033640
130 mm Pan	83033641
190 x 200 mm Pan	83033643
377 x 311 mm Pan (EX12001/24001/35001)	30076186

TABLE 9-8. ACCESSORIES

DESCRIPTION	PART NUMBER
Foot Switch kit	83021086
Terminal Extension Cable kit	83021083
Density Determination kit	80253384
Tower Mount for Terminal	83021102
Draft Shield kit	83021084
Security Device	80850043
Printer	SF-40A
Interface Cable, Printer	Contact Ohaus
Interface Cable, PC 25 pin	Contact Ohaus
Interface Cable, PC 9 pin	Contact Ohaus
Interface Cable, USB (Type A to B)	83021085
Second RS232 Option kit	83021081
Ethernet Option Kit	83021082
External Rechargeable Battery Pack	30041295
Adjustable Rolling Feet	30041470
Auxiliary Display(PAD7)	80251396

9.4 Icons List

TABLE 9-9. EXPLORER BALANCE ICONS



ICON	FUNCTION	ICON	FUNCTION
	Standby		User Settings Menu
	Print		Balance Setup Menu
	Applications		Application Modes Menu
	Sensors		Weighing Units Menu
	AutoCal™		GLP and GMP Data Menu
	Main Menu		Communication Menu
	More Functions...		Library
	Level Assist		I/O Settings menu
	Zero		Diagnostics Menu
	Tare		Factory Reset Menu
	Units		lockout Menu
	Pre-Tare		Information Menu
	Cal Test		Battery
	Calculator		Left Door
	Stopwatch		Right Door
	Logout		Automatic draftshield door
	Calibration Menu		

TABLE 9-9. EXPLORER BALANCE ICONS (Continued)





ICON	FUNCTION	ICON	FUNCTION
	AutoCal™ Internal Calibration		Stability Indicator Range
	Automatic Calibration		Filter Level
	AutoCal™ Adjustment		Auto Zero Tracking
	Span Calibration		Auto Tare
	User Calibration		Gross Indicator
	Calibration Test		Legal For Trade
	Language		Graduations
	Volume		Date and Time
	Display Settings		
	User Manager		
	Functions Configuration		
	Sensors		
	Draft Shield Light		

TABLE 9-9. EXPLORER BALANCE ICONS (Continued)















ICON	FUNCTION	ICON	FUNCTION
	Weighing		Formulation
	Parts Counting		Differential
	Percent Weighing		Density Determination
	Check Weighing		Peak Hold
	Dynamic Weighing		Ingredient Costing
	Filling		Pipette Adjustment
	Totalization		Statistical Quality Control











TABLE 9-9. EXPLORER BALANCE ICONS (Continued)

ICON	FUNCTION		ICON	FUNCTION
mg	Milligram unit		mom	Momme unit
g	Gram unit		msg	Mesghal unit
kg	Kilogram unit		HKt	Hong Kong Tael unit
ct	Carat unit		SGt	Singapore Tael unit
oz	Ounce unit		TWt	Taiwan Tael unit
ozt	Ounce Troy unit		tical	Tical unit
lb	Pound unit		tola	Tola unit
dwt	Pennyweight unit		bht	Baht unit
Grain	Grain unit		C1	Custom unit 1
N	Newton unit		C2	Custom unit 2
			C3	Custom unit 3

TABLE 9-9. EXPLORER BALANCE ICONS (Continued)

ICON	FUNCTION	ICON	FUNCTION
	Header		Calibration Reset
	Balance Name		User Settings Reset
	User Name		Balance Setup Reset
	Project Name		Application Modes Reset
	RS 232 Standard		Weighing Units Reset
	USB Standard		GLP and GMP Data Reset
	External Input 1		Communication Reset
	External Input 2		I/O Settings Reset
	External Input 3		Reset All
	External Input 4		
	Level Bubble Light		
	Draft Shield Light		
	Sensors		
	Service Menu		

TABLE 9-9. EXPLORER BALANCE ICONS (Continued)

ICON	FUNCTION	ICON	FUNCTION
	Calibration Lockout		
	User Settings Lockout		
	Balance Setup Lockout		
	Application Modes Lockout		
	Weighing Units Lockout		
	GLP and GMP Data Lockout		
	Communication Lockout		
	Library Lockout		
	I/O Settings Lockout		
	Factory Reset Lockout		

9.5 Communication

9.5.1 Interface Commands

Commands listed in the following table will be acknowledged by the balance.

The balance will return “ES” for invalid commands.

TABLE 9-10. EXPLORER INTERFACE COMMAND LIST

Command Characters ¹⁾	Function
IP	Immediate Print of displayed weight (stable or unstable). Attention: when LFT ON, IP could only print stable displayed weight.
P ¹⁾	Print displayed weight according to “Stable only” setting in the communication menu. Attention: when LFT ON, P could only print stable displayed weight.
CP	Continuous Print. Attention: when LFT ON, CP could not work.
SP ¹⁾	Print on Stability.
SLP	Auto Print stable non-zero displayed weight. Attention: the corresponding settings in the communication menu are modified too.
SLZP	Auto Print stable non-zero weight and stable zero reading. Attention: the corresponding settings in the communication menu are modified too.
xP	Interval Print x = Print Interval (1-3600 sec) 0P ends interval Print. Attention: the corresponding settings in the communication menu are modified too.
0P	See above.
H	Enter or get Print Header Lines. Attention: header text length is up to 25 characters, the setting format is “H x “header line text””; and “H x” could get the corresponding header line in the balance.
Z	Same as pressing Zero Key
T	Same as pressing Tare Key.
xT	Establish a preset Tare value in displayed unit. X = preset tare value. Sending 0T clears tare (if allowed).
PT	Prints Tare weight stored in memory.
PM	Print current application mode (weighing mode).
xM	Set current application mode to x. x depends on application, use application list ²⁾ .
M	Scroll to the next enabled mode.
PU	Print Current weighing unit: g, Kg, lb, oz, etc....
xU	Set balance to unit x: g, Kg etc. x depends on unit list ³⁾ .
U	Scroll to the next enabled unit.
ON	Brings out of Standby
OFF	Goes to Standby.
C	Begin Span Calibration, same as trigger from calibration menu. Attention: when LFT ON, the operation is not allowed.
IC	Begin internal Calibration, same as trigger from calibration menu.
UC	User Calibration (uses default weight), same as trigger from calibration menu. Attention: when LFT ON, the operation is not allowed.
AC	Abort Calibration. Attention: when LFT ON, the operation is not allowed.
xUC	Set user defined weight and trigger one user calibration. Attention: the user defined weight is only used for this command.

TABLE 9-10. EXPLORER INTERFACE COMMAND LIST (continued)

Command Characters ¹⁾	Function
PSN	Print Serial Number.
PV	Print terminal software version, base software version and LFT ON (if LFT is set ON).
x#	Set Counting APW (x) in grams. (must have APW stored)
P#	Print Counting application APW.
x%	Set Percent application reference weight (x) in grams. (must have reference weight stored)
P%	Print Percent application reference weight.
xAW	Set Dynamic Weigh Level to x. (x = 1 - 99 seconds)
xAW	Set Dynamic Weigh Mode. x = A (Automatic), S (Semi-Automatic), M (Manual)
PAW	Print Dynamic Weigh Level.
BAW	Start Dynamic Weigh cycle. (Manual Mode)
CW	Clear locked weight (weight < threshold) in Dynamic Weigh (same as button "Reset") & Display Hold (same as button "End Peak Hold").
xCO	Set Checkweighing Over Limit in grams x.
xCU	Set Checkweighing Under Limit in grams x.
PCO	Print Checkweighing Over Limit.
PCU	Print Checkweighing Under Limit.
xCM	Set Checkweigh mode (1=over/under, 2=Target/weight tolerance, 3=target/% tolerance)
xCT%	Set Checkweighing target in grams x for percent tolerance mode.
PCT%	Print Checkweighing Target for percent tolerance mode.
xCTW	Set Checkweighing target in grams x for weight tolerance mode.
PCTW	Print Checkweighing Target for weight tolerance mode.
xC%	Set Checkweighing % tolerance x. Attention: when x is a positive value, it is used to set the +tolerance value; vice versa.
PC%	Print Checkweighing % tolerance.
xCW	Set Checkweighing weight tolerance x. Attention: when x is a positive value, it is used to set the +tolerance value; vice versa.
PCW	Print Checkweighing weight tolerance.
xDH	Set Display Hold mode (Peak Hold). x = A (Automatic), S (Semi-Automatic), M (Manual)
xD	Set 1 second print delay (set x = 0 for OFF, or x = 1 for ON).
xFL	Set filter level to x (1 = low, 2 = med, 3 = high).
xAL	Set Auto-zero to x (x = 1 for 0d, x = 2 for 0.5d, x = 3 for 1d, x = 4 for 3d).
Esc R	Resets all Balance menus to factory defaults. Attention: The binary code of this commands is "1B 20 52 0D 0A" or "1B 52 0D 0A".
PID	Print current user Name.
xID	Program user Name. Attention: only allowed numeric input.
xTL	Set Totalize Mode. x = A (Automatic), M (Manual).
PTIME	Print current time.
PDATE	Print current date.
xTIME	Set Time, x format: hh:mm:ss.
xDATE	Set Date, x format: mm/dd/yyyy.
CA	Continuous weight, same as CP.
SA	Stable load, same as SLP.
xA	Interval Print x = interval in sec (1-3600) 0 = off, same as xP.
0A	Set AutoPrint off, same as 0P.
SC	Begin Span Cal, same as C.
xAM	Set Animal Mode to Auto, Semi-Auto, Manual. Same as xAW(A/S/M)
?	Prints current mode, same as PM.
xS	0 = print unstable data, same as IP; 1 = print stable only ¹⁾ , same as SP.
xRL	0 = disable response; 1 = enable response. This command only controls the "OK!" response.

General Notes:

Commands sent to the indicator must be terminated by a carriage return-line feed (CRLF).

Alternate command characters may be defined by the user.

Data output is always terminated with a carriage return-line feed (CRLF).

Note 1) There is 40-second timeout control for print under stable requirement. If the unstable condition continues over 40 seconds, balance will respond "ES".

Note 2) Application list:

Index	Application		Index	Application
0	Weighing		11	Ingredient Adjustment
1	Parts Counting		12	Pipette Adjustment
2	Percent Weighing		13	SQC
3	Check Weighing			
4	Dynamic Weighing			
5	Filling			
6	Totalization			
7	Formulation			
8	Differential			
9	Density Determination			
10	Peak Hold			

Note 3) Unit list:

Index	Unit		Index	Unit
0	Milligram		11	Mesghal
1	Gram		12	Hong Kong Tael
2	Kilogram		13	Singapore Tael
3	Carat		14	Taiwan Tael
4	Ounce		15	Tical
5	Ounce Troy		16	Tola
6	Pound		17	Baht
7	Pennyweight		18	Custom Unit 1
8	Grain		19	Custom Unit 2
9	Newton		20	Custom Unit 3
10	Momme			

9.5.2 RS232 (DB9) Pin Connections

- Pin 2: Balance transmit line (TxD)
- Pin 3: Balance receive line (RxD)
- Pin 5: Ground signal (GND)
- Pin 7: Clear to send (hardware handshake) (CTS)
- Pin 8: Request to send (hardware handshake) (RTS)

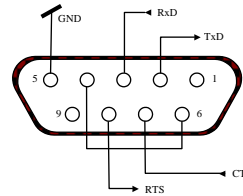

9.6 The USB Interface

The Ohaus USB Interface is a unique solution to the problem of connecting a balance to a computer using a Universal Serial Bus (USB). USB devices are categorized into classes such as disk drives, digital cameras, printers, etc. Balances do not have a commonly used class so the Ohaus USB interface uses a generic interface based on the RS232 serial standard.

Data sent from the balance to a computer is in USB format. The USB data is directed to a *virtual port*. This port then appears as an RS232 port to the application program.

When sending a command from a computer to the balance, the application program sends a command to the *virtual port* as if it were an RS232 port. The computer then directs the command from the *virtual port* to the computers USB connector where the balance is connected. The port receives the USB signal and reacts to the command.

The USB Interface includes a CD with the software drivers to create the required *virtual port* on the computer.

System Requirements

- PC running Windows 98®, Windows 98SE®, Windows ME®, Windows 2000®, Windows XP® or Windows 7®
- Available USB port (Type A, 4-pin, female)

USB Connection

The balance's USB port terminates with a mini USB.

A USB Cable (type B/male to type A/male) is required (not supplied).

1. Ensure that the balance is powered on and working properly.
2. Power on the computer and verify that its USB port is enabled and working properly.
3. Plug the cable's USB connectors into the computer's USB port and the balance's USB port. Windows® should detect a USB device and the New Hardware Wizard will be initialized.

Virtual Port Software Installation

1. Insert the supplied CD into the computer's CD drive.
Different versions of Windows® have slightly different steps to load the driver that is on the CD. In all versions the New Hardware Wizard guides you through the required steps to select the driver that is located on the CD.
2. After clicking Finish, the virtual port should be ready for use.
Windows® typically adds the virtual port in sequence after the highest number COM port. For example, on PC's equipped with up to 4 COM ports, the virtual port will be COM5.

When using the USB interface with programs that limit the number of COM port designations (e.g. Ohaus MassTracker allows only COM1, 2, 3, & 4), it may be necessary to assign one of these port numbers to the new virtual port.

This can be done in the Port Settings of the Device Manager utility, found in the Windows Control Panel.



Example of Windows XP Hardware Wizard

Balance Setup for USB Interface

A) The Ohaus Interface is preset to communicate using the following settings:

9600 baud, 8 bit, no parity, no handshake, 1 stop bit.

This is a fixed setting and cannot be changed.

B) Configure the balance to the desired USB and printing parameters.

PRINT

Stable

On, Off

A-Print

Cont, On.Stbl, On.Acc*, 5sec, 15sec, 30sec,
60sec, off

End

Yes, No

*Note: Print and USB menu selections may vary between the different balance series.

USB

USB

On / Off

Baud

600, 1200, 2400, 4800, 9600, 19200

Parity

7-even, 7-odd, 7-none, 8-none

Handshake

None, Xon-Xoff, RTS-CTS

END

Yes, No

SETUP DEFINITIONS

PRINT / Stable – On

Balance transmits stable data only.

PRINT / Auto Print – Continuous

Balance repeatedly sends data as fast as possible.

PRINT / Auto Print – On Stable

Balance automatically outputs data upon stability.

PRINT / Auto Print – (xx) sec

Balance sends data every (xx) seconds.

PRINT / Auto Print – Off

Only sends data when PRINT is pressed.

USB / USB – Off

Turns Interface off, saving battery power.

USB / Baud, Parity, Handshake

Set parameters to match printer or computer.

Operation**USB OUTPUT**

With the Adapter installed the balance will operate in one of the following three ways:

- USB = On, Auto Print = Off, Stable = On or Off
Press PRINT to send the display data based on the settings in the Menu.
If Stable is set to On, the balance will wait for a stable reading before sending data.
- USB = On, Auto Print = On, Stable = On or Off
The balance will automatically send data.
If Stable is set to On, only stable values will be sent.
- USB = Off
The interface is turned off.

Data sent from the Interface is in standard ASCII format terminated with a [CRLF] (carriage return-line feed). The output format is as follows:

[weight]	10 characters	(right justified)
[space]	1 character	
[unit]	5 characters max	(left justified)
[space]	1 character	
[stability indicator]	1 character	"?" when unstable, blank when stable
[space]	1 character	
[legend]	10 character	TOTAL, hh:mm:ss(time interval), etc.
[CR]	1 character	
[LF]	1 character	

Output examples: (Note: * and _ indicate spaces)

```
*****192.21_g
*****0.01_g_?

*****0.01_g__00:00:00
*****176.30_g_?_00:00:15
*****192.08_g__00:00:30

*****192.21_g
*****207.80_g_TOTAL
```

– Manual, Continuous or On-Stable printing
unstable reading

– Interval Printing (example:15sec interval)
unstable reading

– Accumulate Mode (Manual printing only)

USB INPUT

The balance will respond to various commands sent via the interface adapter. Terminate the following commands when with a [CR] or [CRLF].

Explorer Commands

?	print current mode
0A	turn Auto-print off
SA	Auto-print on, prints on stability
CA	Continuous Auto-print
(n)A	Auto-print on 1 to 3600 second intervals (n = 1 to 3600)
C	perform span calibration
T	tare balance, same as pressing ON-ZERO
V	print software version
(Esc)R	reset balance to factory defaults
P	same as pressing PRINT
0S	print unstable data
1S	print stable data only
P	same as pressing Print
SP	print stable weight only
IP	immediate print of displayed weight (stable or unstable)
CP	Continuous print of weights
SLP	Auto-print stable non-zero weight only
SLZP	Auto-print stable non-zero weight and zero reading
xP	Auto-print on 1 to 3600 second intervals (x = 1 to 3600)
0P	turns auto-print off
PM	print current mode
M	advance to the next enabled mode
PU	print current unit
U	advance to the next enabled unit
T	same as pressing Tare
Z	same as pressing Zero
PV	print software version

Auto-Print Operation

Once Auto-Print is activated in the menu, the balance will send data as required.

To temporarily stop Auto-Printing, press PRINT.

If there is data in the print buffer the printer will finish printing this data.



A second press will resume Auto-Printing.



10. SOFTWARE UPDATES

Ohaus is continuously improving its balance software. To obtain the latest release, please contact your Authorized Ohaus Dealer or Ohaus Corporation.

11. COMPLIANCE

Compliance to the following standards is indicated by the corresponding mark on the product.

Mark	Standard
	This product conforms to the EMC Directive 2004/108/EC, the Low Voltage Directive 2006/95/EC and the Non-automatic Weighing Instruments Directive 2009/23/EC. The complete Declaration of Conformity is available online at www.ohaus.com .
	AS/NZS CISPR 11, AS/NZS 61000.4.3
	CAN/CSA-C22.2 No. 61010-1-04 UL Std. No. 61010-1

	<p>Important notice for verified weighing instruments</p> <p>Weighing instruments verified at the place of manufacture bear one of the preceding marks on the packing label and the green 'M' (metrology) sticker on the descriptive plate. They may be put into service immediately.</p>
	<p>Weighing instruments to be verified in two stages have no green 'M' (metrology) on the descriptive plate and bear one of the preceding identification marks on the packing label. The second stage of the initial verification must be carried out by the approved service organization of the authorized representative within the EC or by the national weights and measures (W+M) authorities.</p> <p>The first stage of the initial verification has been carried out at the manufacturer's work. It comprises all tests according to the adopted European standard EN45501:1992, paragraph 8.2.2.</p> <p>If national regulations limit the validity period of the verification, the user of the weighing instrument must strictly observe the re-verification period and inform the respective W+M authorities.</p>

FCC Note

This equipment has been tested and found to comply with the limits for a Class A digital device, pursuant to Part 15 of the FCC Rules. These limits are designed to provide reasonable protection against harmful interference when the equipment is operated in a commercial environment. This equipment generates, uses, and can radiate radio frequency energy and, if not installed and used in accordance with the instruction manual, may cause harmful interference to radio communications. Operation of this equipment in a residential area is likely to cause harmful interference in which case the user will be required to correct the interference at his own expense.

Industry Canada Note

This Class A digital apparatus complies with Canadian ICES-003.

ISO 9001 Registration

In 1994, OHAUS Corporation, USA, was awarded a certificate of registration to ISO 9001 by Bureau Veritas Quality International (BVQI), confirming that the OHAUS quality management system is compliant with the ISO 9001 standard's requirements. On June 21, 2012, OHAUS Corporation, USA, was re-registered to the ISO 9001:2008 standard.

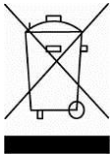
**Disposal**

In conformance with the European Directive 2002/96/EC on Waste Electrical and Electronic Equipment (WEEE) this device may not be disposed of in domestic waste. This also applies to countries outside the EU, per their specific requirements.

The Batteries Directive 2006/66/EC introduces new requirements from September 2008 on removability of batteries from waste equipment in EU Member States. To comply with this Directive, this device has been designed for safe removal of the batteries at end-of-life by a waste treatment facility.

Please dispose of this product in accordance with local regulations at the collecting point specified for electrical and electronic equipment.

If you have any questions, please contact the responsible authority or the distributor from which you purchased this device.

Should this device be passed on to other parties (for private or professional use), the content of this regulation must also be related.

For disposal instructions in Europe, refer to www.ohaus.com , choose your country then search for WEEE.

Thank you for your contribution to environmental protection.

LIMITED WARRANTY

Ohaus products are warranted against defects in materials and workmanship from the date of delivery through the duration of the warranty period. During the warranty period Ohaus will repair, or, at its option, replace any component(s) that proves to be defective at no charge, provided that the product is returned, freight prepaid, to Ohaus.

This warranty does not apply if the product has been damaged by accident or misuse, exposed to radioactive or corrosive materials, has foreign material penetrating to the inside of the product, or as a result of service or modification by other than Ohaus. In lieu of a properly returned warranty registration card, the warranty period shall begin on the date of shipment to the authorized dealer. No other express or implied warranty is given by Ohaus Corporation. Ohaus Corporation shall not be liable for any consequential damages.

As warranty legislation differs from state to state and country to country, please contact Ohaus or your local Ohaus dealer for further details.



Ohaus Corporation
7 Campus Drive
Suite 310
Parsippany, NJ 07054 USA
Tel: (973) 377-9000
Fax: (973) 944-7177

With offices worldwide.
www.ohaus.com



P/N 83021171 I © 2014 Ohaus Corporation, all rights reserved.